

A photograph showing a white, modern-style fence made of vertical slats. The fence is installed along the edge of a wooden deck that borders a swimming pool. The background consists of a dense green hedge. The lighting is bright, suggesting a sunny day.

PIK[®] FENCING

The essentials.

<p>PAGE 5 Introduction</p>	<p>PAGE 8 PIK® Joining Overview</p>
<p>PAGE 10 PIK® Hardware</p>	<p>PAGE 31 Order Codes</p>
<p>PAGE 32 Installation Overview</p>	<p>PAGE 45 Logistics Overview</p>



Due to space restrictions, not all stock featured in this catalogue is stocked at all depots.

We recommend touching base with your closest depot prior to order placement if unsure.

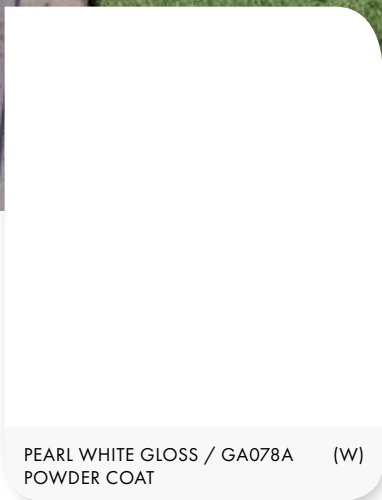
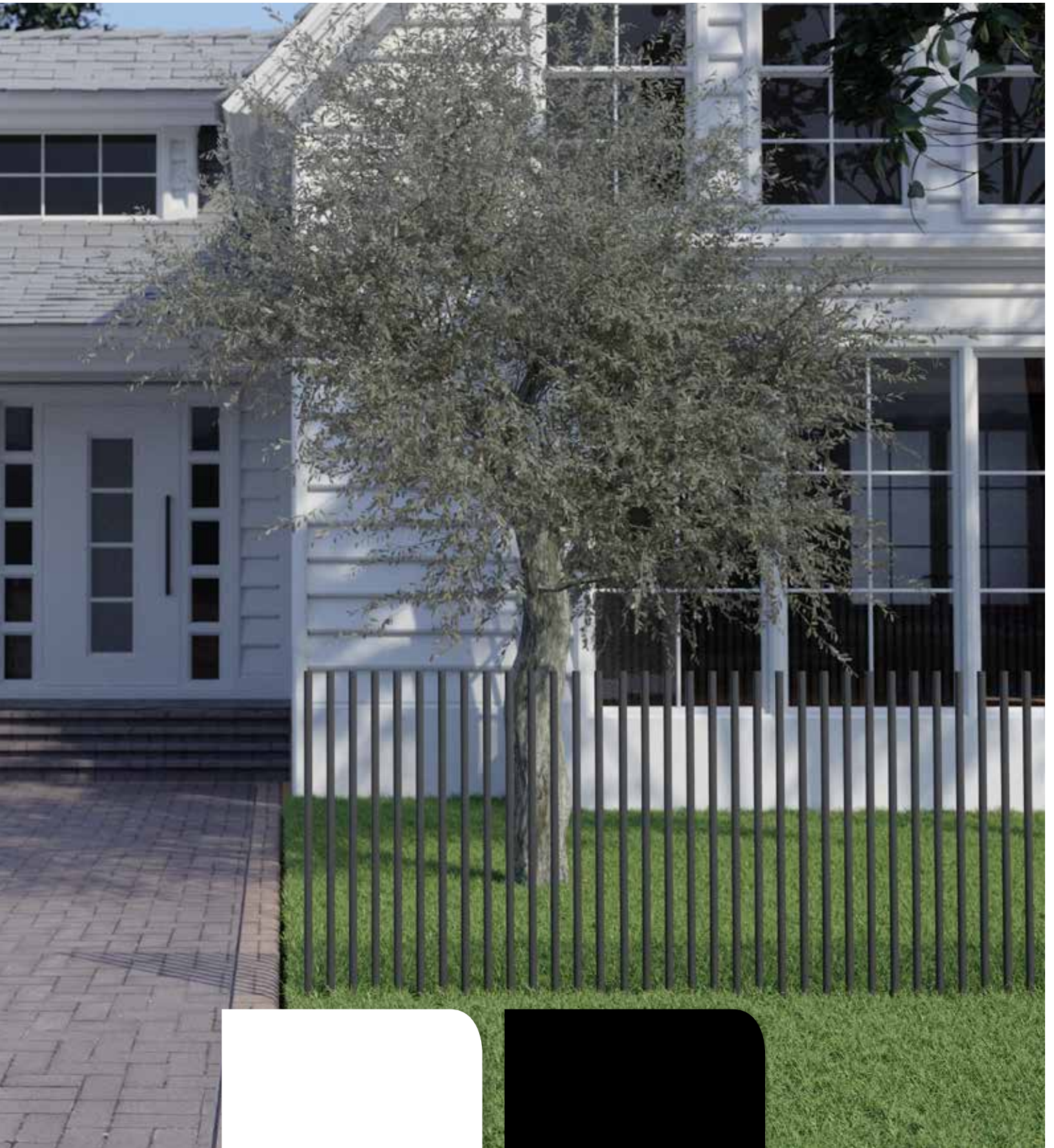

PEARL WHITE GLOSS / GA078A (W)
POWDER COAT

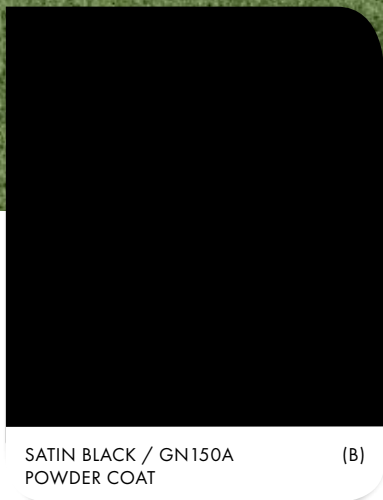

SATIN BLACK / GN150A (B)
POWDER COAT

Note: Colours displayed are a guide only

INTRODUCING PIK®

We are thrilled to offer a breakthrough in architectural fencing that not only ensures the highest level of safety but also elevates the aesthetics to new heights.

Designed by a team of talented designers and engineers, PIK® combines cutting-edge manufacturing processes, sleek lines, and innovative features to create a truly exceptional fencing solution. We have meticulously crafted every detail to seamlessly integrate with the outdoor space, enhancing overall architectural design.

Our stylish vertical picket fencing is designed with durability in mind. The galvanised steel round powder coated balusters with epoxy base coat are selected for their resistance to weather elements, ensuring the fence maintains its aesthetic appeal for years to come.

The vertical orientation of the pickets provides a sense of height and openness while ensuring privacy and security. Additionally, the spacing of pickets provides for pool fencing compliance. This design allows air and light to flow through, creating a bright and airy atmosphere.

Safety is top priority, and PIK® excels in this aspect as well. The vertical round picket panels are made from heavy duty galvanised steel. Precise engineering and installation methods ensure that the fence is secure and durable and importantly, meets relevant pool fencing standards.

What sets our round vertical picket fencing apart is its versatility. Whether you're looking to define your garden space, enclose a pool area, or add a contemporary touch to your property's perimeter, our fencing solution offers a seamless integration with any architectural style or landscaping design. It effortlessly harmonises with both modern and traditional settings, making it a versatile choice for any outdoor project.

With PIK®, we invite you to redefine the concept of fencing. Experience the perfect harmony of safety and style, where your fence line becomes a stunning focal point that exudes sophistication and elegance.

We take pride in delivering not only stylish fencing solutions but also exceptional craftsmanship and customer satisfaction. Our team of experts is ready to work closely with you to understand your unique requirements and bring your vision to life.

PLINTH FIXING OPTIONS

1) Bolted to concrete/timber

Pickets are prewelded to a 12mm thick plinth which is 1200mm long x 100mm wide. Simply install a complete panel onto a concrete or timber surface via 6 x fixing holes located in each plinth.

2) Bury in grout

Another option is to bury the plinth in grout so that it is hidden and only pickets protrude upwards. Alternatively, separate pickets are available which may be installed individually.

For details on fitting options see page 11.

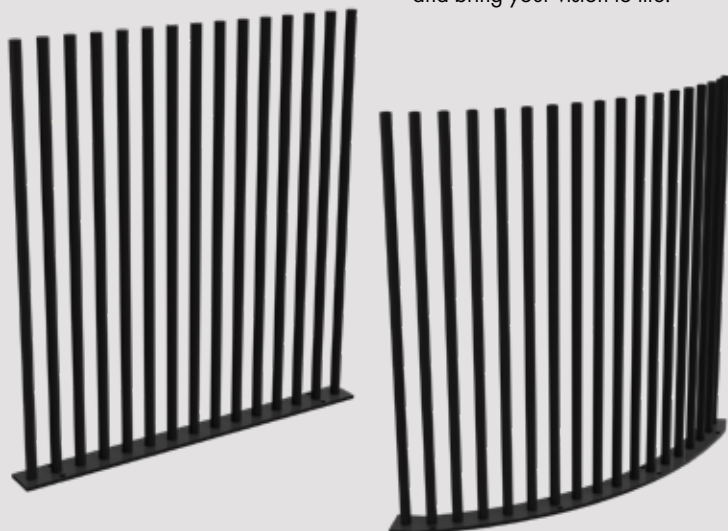



Architectural pool fencing aims to enhance the visual appeal of the pool area while integrating seamlessly with the surrounding architecture. Our round vertical picket fencing combines sleek lines, high-quality materials, and a versatile design to create a visually striking and stylish boundary. With its clean and linear look, this fencing solution adds a touch of modern sophistication to any setting.

BENEFITS OF GALVANISED STEEL



STRENGTH

With significantly higher tensile strength than aluminium, galvanised steel fencing offers unrivalled strength and resilience.



NON COMBUSTIBLE

Steel is described as non-combustible. Steel is an excellent choice where fire risk requires consideration.



CORROSION RESISTANT

Galvanized steel is coated with a layer of zinc, which provides a protective barrier against moisture and environmental factors that lead to corrosion.



EPOXY BASE COAT

Epoxy coatings applied to galvanised steel prior to powder coating provide excellent resistance to corrosion. The coating acts as a barrier, preventing water, oxygen, and corrosive chemicals from coming into direct contact with the steel. Each PIK® panel/pickets feature epoxy base coat.



DURABLE POWDER COAT

Powder coating provides outstanding long term colour fastness and stability.



WIPE CLEAN

Enjoy minimal maintenance with PIK® with the ease of a simple wipe/hose down clean.

PIK[®] JOINING OVERVIEW



PIK[®] JOINING OVERVIEW

Straight

Join several straight plinths together. Plinths can either be bolted onto concrete/timber or buried into grout. There may be instances where individual PIK[®]'s may be needed if the land is not level, if raking is required or deeper embedment of pickets required. If this occurs, individual PIK[®]'s from 'kit in a box' can be utilised.

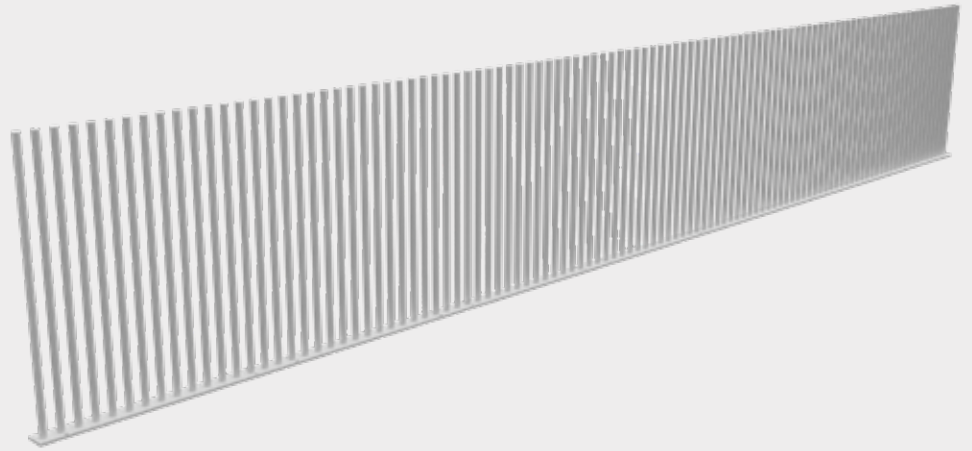

Straight and curved

Join several straight plinths together. Plinths can either be bolted onto concrete/timber or buried into grout. Where a 90° curve is required, join the curved plinth as desired to straight panels. The curved plinth is a pre-welded and ready to install 90° corner panel. If an alternative curve is required, choose the 'kit in a box' and set to the desired angle/radius using individual PIK[®]'s.

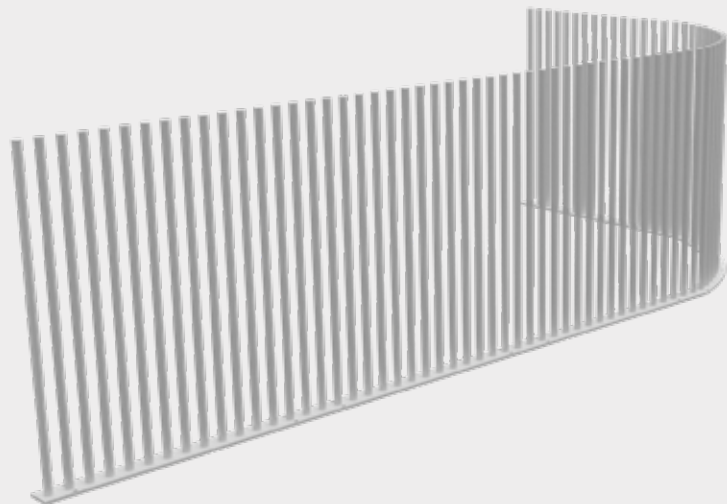

Organic curve

When an organic curve is required, choose the 'kit in a box' to arrange PIK[®]'s as desired. Specially designed removable clips are supplied for the top and bottom of pickets to maintain consistency of spacing through curves during the installation process.

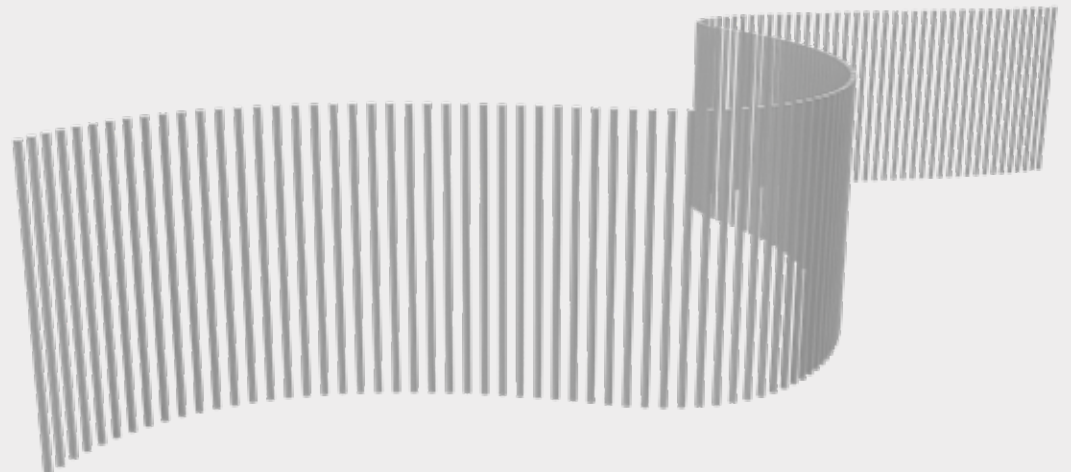

PIK® FENCING

Panel

1200mm W x 1280mm H
Satin Black or Pearl White finish

Order Code: **SC-11067 (Black)**
SC-11068 (White)

- Made from galvanised steel with epoxy base coat then powder coated
- Epoxy base coat provides excellent resistance to corrosion in addition to galvanised steel
- Vertical pickets are 32mm diameter (3mm wall thickness steel)
- Plinth is 1200mm long x 100mm wide x 12mm thick (6 x fixings holes per plinth)
- 1200mm wide panels may be butted up to each other to create continuous runs
- Vertical pickets are welded to plinth
- Pickets are at 80mm centre to centre (provides 48mm gaps)
- Pool fence compliant to AS1926.1
- Top cap pre-inserted into each picket
- Each panel weighs 52kg

FINISHES

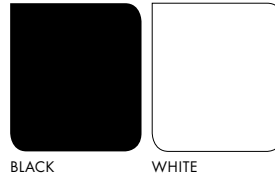

BLACK

WHITE

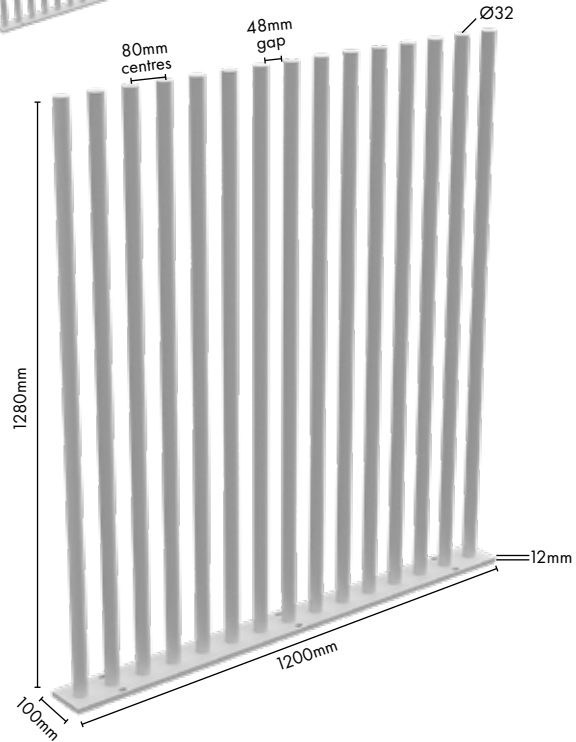
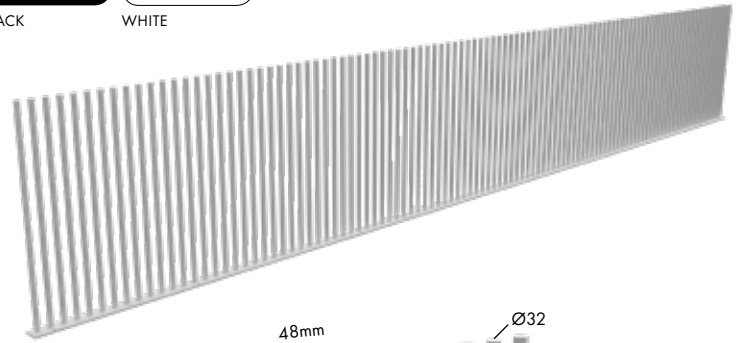

BENEFITS OF EPOXY BASE COAT

Panels are made from galvanised steel. Galvanised steel is coated with a layer of zinc, which provides a protective barrier against moisture and environmental factors that lead to corrosion. For increased corrosion resistance, an EPOXY BASE COAT is applied to the galvanised steel prior to powder coating.



Corrosion Resistance

The epoxy coating acts as a barrier, preventing water, oxygen, and corrosive chemicals from coming into direct contact with the steel and initiating the corrosion process.



Adhesion

Epoxy coatings have superior adhesion properties. This strong bond to the steel surface ensures that the coating remains intact, offering long-term protection without peeling or flaking.



Chemical Resistance

Epoxy-coated steel is resistant to a wide range of chemicals, making it suitable for use in environments where the steel might be exposed to harsh substances, including acids, alkalis, and solvents.



Moisture Resistance

The impermeable nature of epoxy coatings makes them highly resistant to moisture, reducing the risk of rust and other forms of moisture-induced degradation.

PIK® OVERVIEW

OVERVIEW OF PLINTH

- 15 x pickets are welded to a 1200mm long x 12mm thick x 100mm wide steel plinth.
- On the plinth underside, 4 x threaded nutserts are internally welded to receive M16 thread so that threaded rod or picket extenders may be screwed in (refer Pg20 for more details).
- The last picket at each end is 40mm from centre to edge of plinth so that plinths may be butted up continuously to achieve seamless fence runs of 80mm centre to centre of picket.

VIEW OF UNDERSIDE OF PLINTH

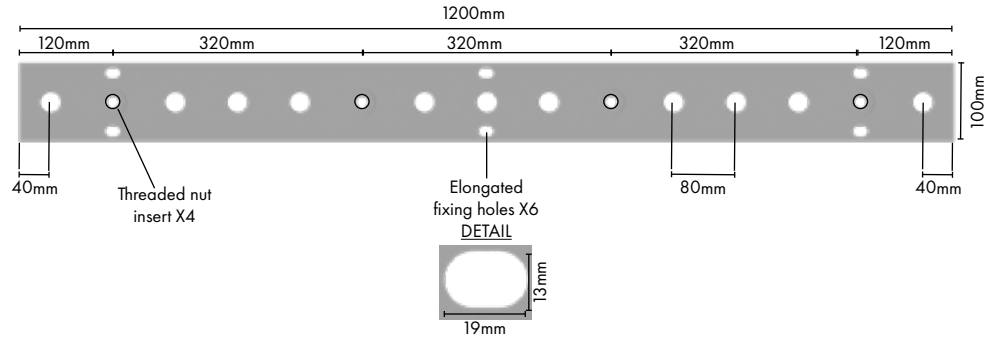

OVERVIEW OF SURFACE MOUNT INSTALLATION

- 1200mm long panels with plinth may be fixed down to a surface. Each plinth has 6 x elongated fixing holes suitable for M10 or M12 fixings. Use packers underneath the plinth as required for an uneven surface.
- If not all fixings holes are used, an oval plug may be used (refer Pg22)
- Simply butt join 1200mm panel modules together.

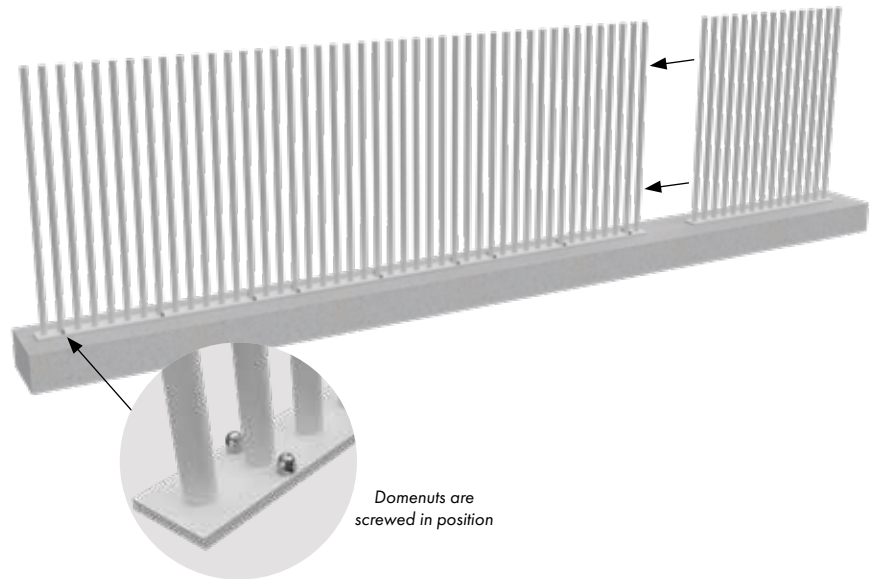

OVERVIEW OF GROUTED IN

- 1200mm long panels with plinth may be recessed and grouted in.
- Panels are 1282mm high from bottom of plinth to top of picket cap. Panels may be recessed approx. 50mm into a channel so that 1230mm of picket protrudes above ground level. If pool fencing compliance required, a minimum of 1200mm above ground level for pickets must be achieved.
- In ground plinths may be butted up against each other and grouted in. To aid in panel alignment and connection, a base joiner is suggested (refer Pg22; code PIK-BASEJOINER-5PK) which can remain in place when grout is poured.

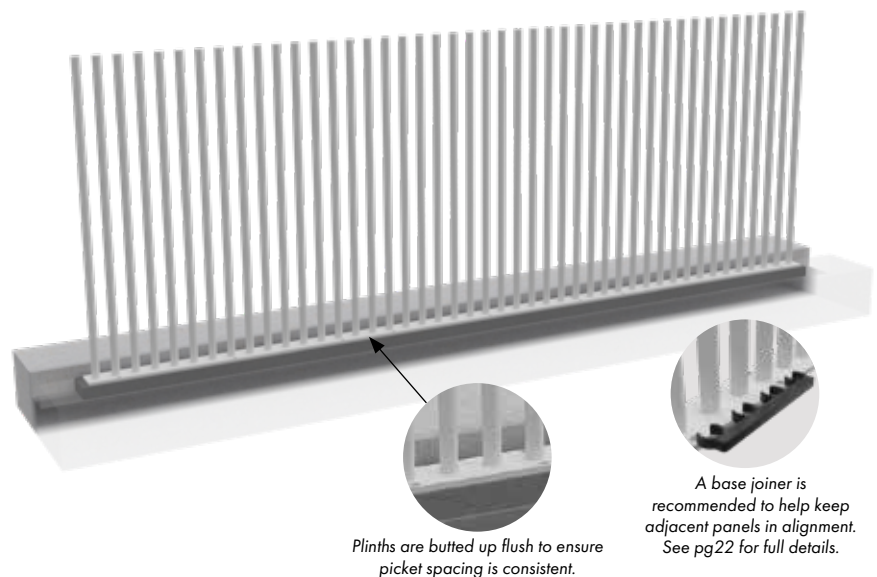

PIK® FENCING

90 degree Curved Corner Panel

1000mm W x 1000mm D x 1280mm H

Satin Black or Pearl White finish

Order Code: **SC-11063 (Black)**

SC-11064 (White)

- Innovative 90 degree pre-made curved panel
- Simply leave a 1000mm x 1000mm space at a corner and pre-made CURVED panel fits the opening size
- Radius of curve is R1311mm
- Same manufacture specifications as straight panel (refer Pg10)
- Pool fence compliant to AS1926.1
- Each panel weighs 61kg
- Straight panels simply butt up to curved panel for easy and seamless installation
- Plinth/panel may be installed onto concrete/timber surface or may be recessed for grout in installation.

FINISHES

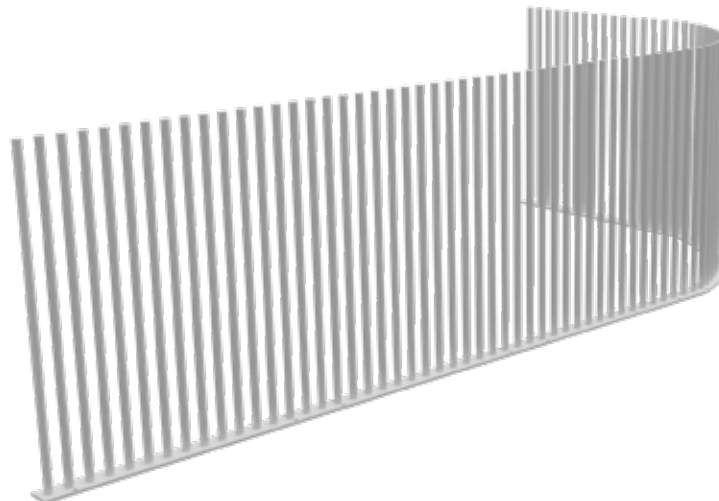
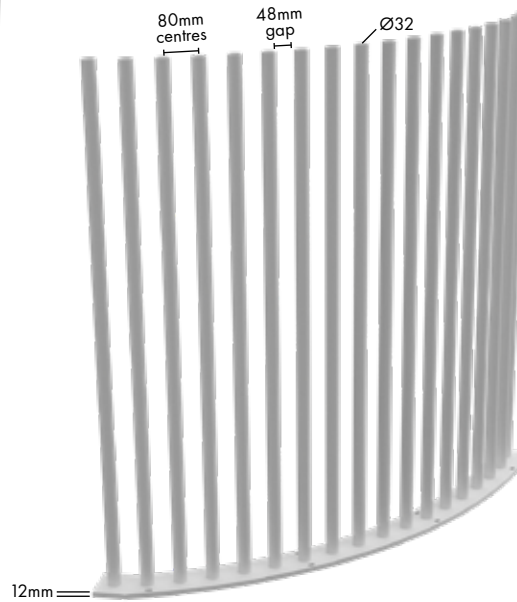
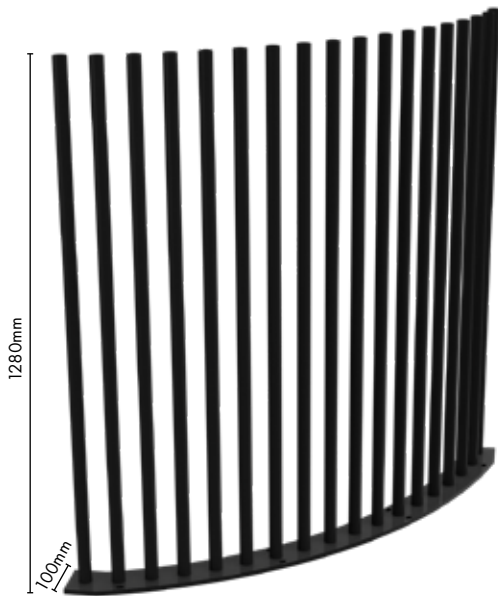
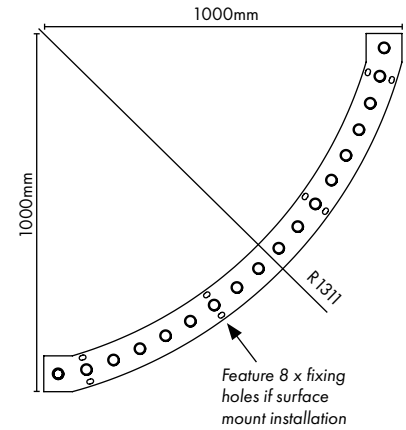
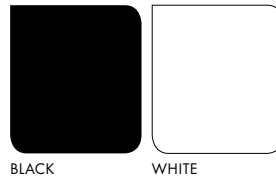

PIK® OVERVIEW

OVERVIEW OF PLINTH

- 18 x pickets are welded to a Radius 1311mm curved x 12mm thick x 100mm wide steel plinth.
- On the plinth underside, 4 x threaded nutserts are internally welded to receive M16 thread so that threaded rod or picket extenders may be screwed in (refer Pg20 for more details).
- Curved plinth fits into a 1 metre x 1 metre opening space. Inline/straight PIK® panels butt up to curved panel.
- The last picket at each end is 40mm from centre to edge of plinth so that plinths may be butted up while still achieving a continuous 80mm centre to centre picket spacing.

VIEW OF UNDERSIDE OF PLINTH

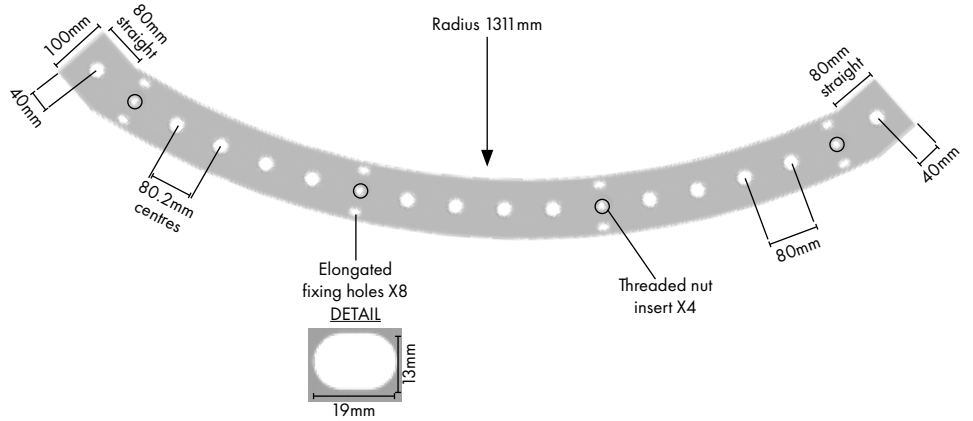

OVERVIEW OF SURFACE MOUNT INSTALLATION

- Curved panels with plinth may be fixed down to a surface. Each plinth has 8 x elongated fixing holes suitable for M10 or M12 fixings.
- If not all fixings holes are used, an oval plug may be used (refer Pg22).
- Simply butt join inline/straight PIK® panels to curved panel.

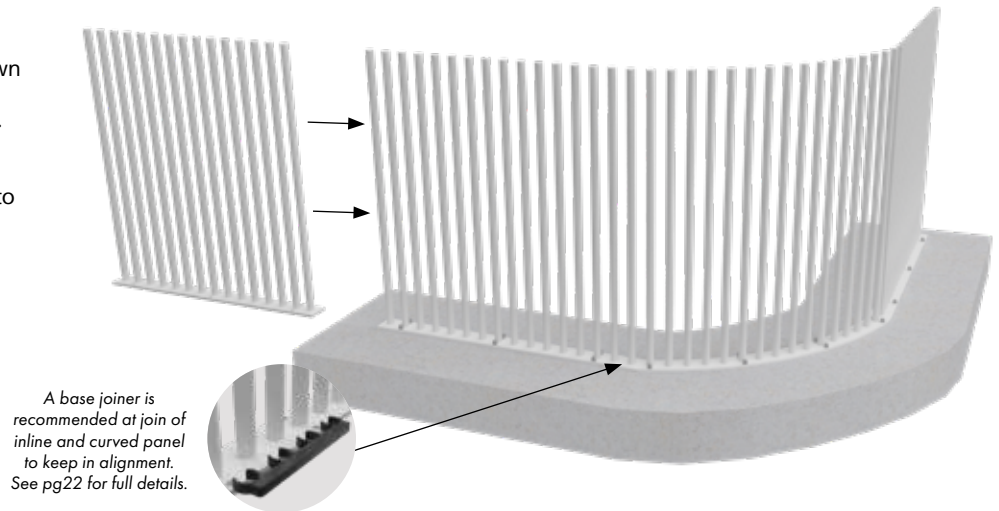

OVERVIEW OF GROUTED IN

- Curved panel with plinth may be recessed and grouted in.
- Panels are 1282mm high from bottom of plinth to top of picket cap. Panels may be recessed approx. 50mm into a channel so that 1230mm of picket protrudes above ground level. If pool fencing compliance required, a minimum of 1200mm above ground level for pickets must be achieved.
- In ground inline/straight plinths may be butted up to the curved panel and grouted in.

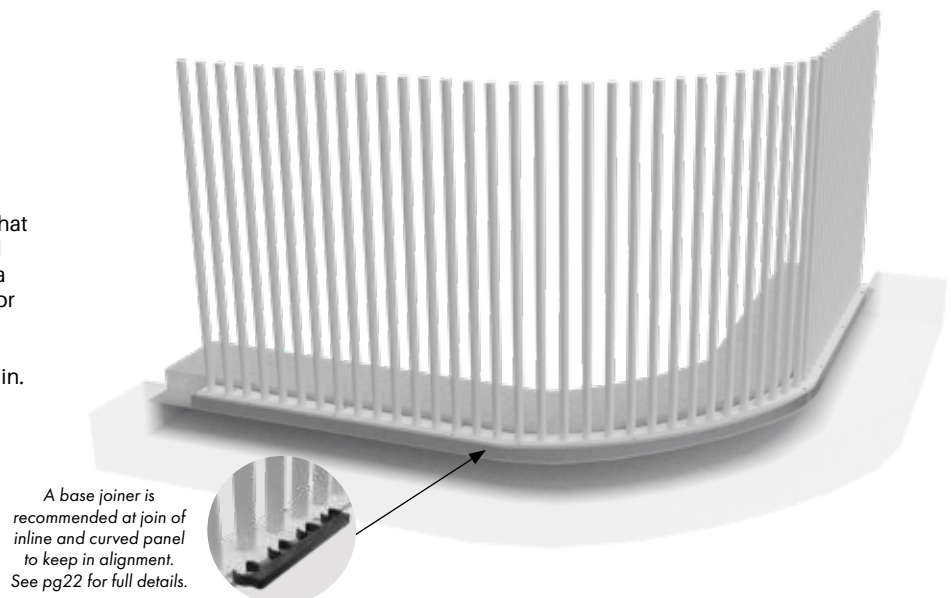

PIK® FENCING

Kit in a Box

752mm W x 1600mm H

Satin Black or Pearl White finish

Order Code: **SC-11065 (Black)**
SC-11066 (White)

• KIT includes

- 10 x 32mm diameter pickets @ 1600mm long
- 10 x top caps
- 10 x "C" top spacer clips
- 10 x "C" bottom spacer clips
- Pickets are 32mm diameter (3mm wall thickness) galvanised steel with epoxy base coat then powder coated
- Epoxy base coat provides excellent resistance to corrosion
- "C" clips are made from polyethylene
- Kit is suitable for use with grout in installation
- Individual pickets are ideal for installation where:
 - higher pickets are required such as step points or change of levels
 - deeper embedment of pickets required grouted directly into ground
 - creating unique shapes or curves
- Join each individual picket with innovative "C" clips top and bottom. The clips ensure accurate and consistent spacing between pickets even when installing not in a straight line
- Bottom "C" clip remains in place when grout poured. Top clip stays installed until grouts sets and then simply remove. Use lever tool for final alignment adjustment of pickets (refer code: PIK-LEVER)
- Clips provide 80mm centre to centre of picket providing 48mm gap spacing: same spacing as PIK 1200mm wide pre-welded panel.
- Spacing compliant to AS1926.1 for pool fencing
- 10 x pickets per kit

FINISHES

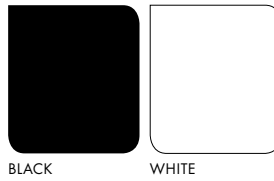

BLACK

WHITE

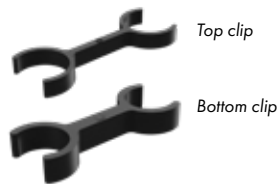
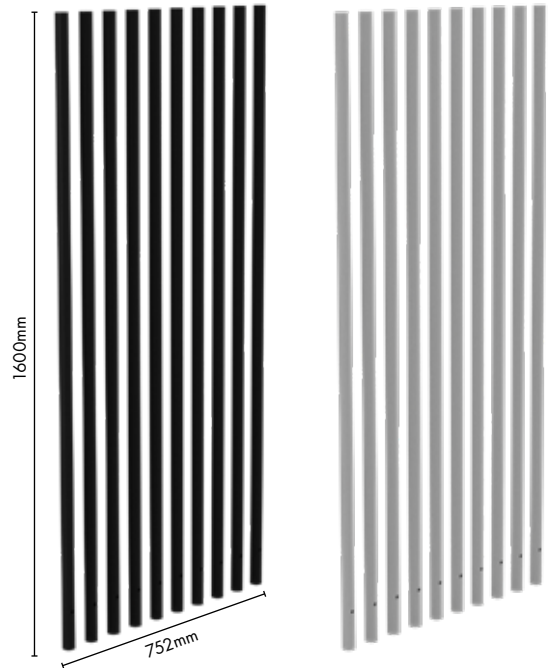

Top clip

Bottom clip

TRADE TIP

Plastic spacer clips will hold individual PIK®'s together to ensure spacing is correct and PIK®'s stay in place when cementing. Using a 'Base Joiner' will also help align PIK®'s. See page 22 for full details.

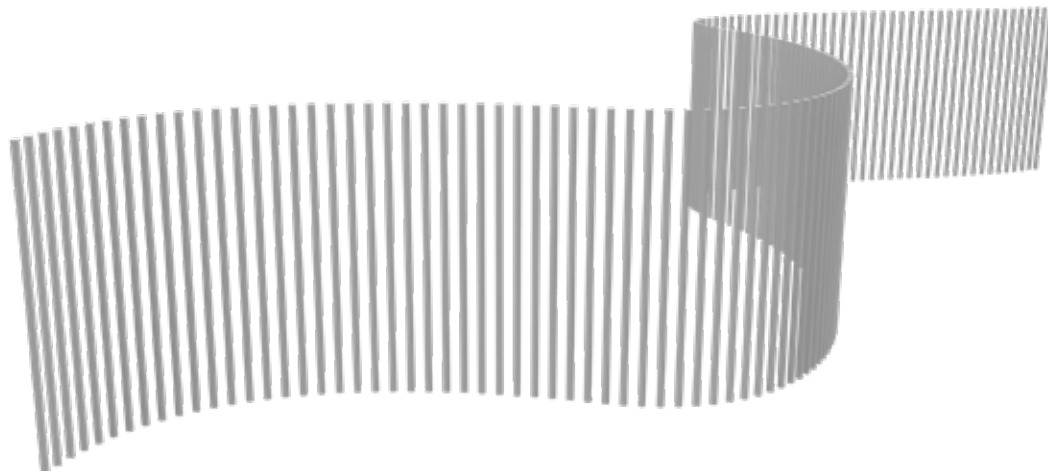

PIK[®] OVERVIEW

'KIT IN A BOX' PIK'S[®] JOINING TO FORM A LINE

Individual pickets are easily joined with "C" clips top and bottom.

The clips simply press onto pickets and provide 80mm spacing centre to centre (48mm gap achieved).

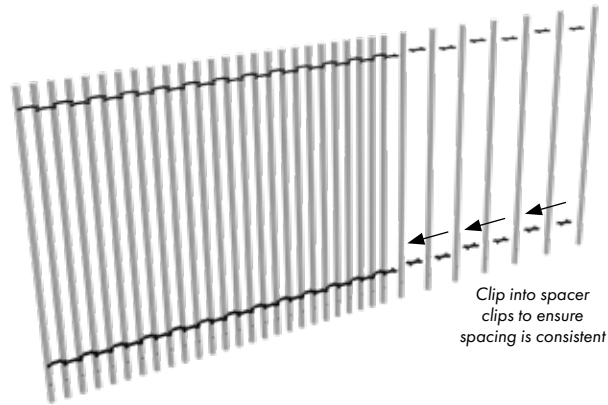

RAKING

Individual pickets can be used to rake up or down where required. For pool fencing application, higher pickets may be used at step points or change of levels.



ORGANIC CURVE

"C" clips keep consistent 80mm centre to centre of picket even when creating organic curves.

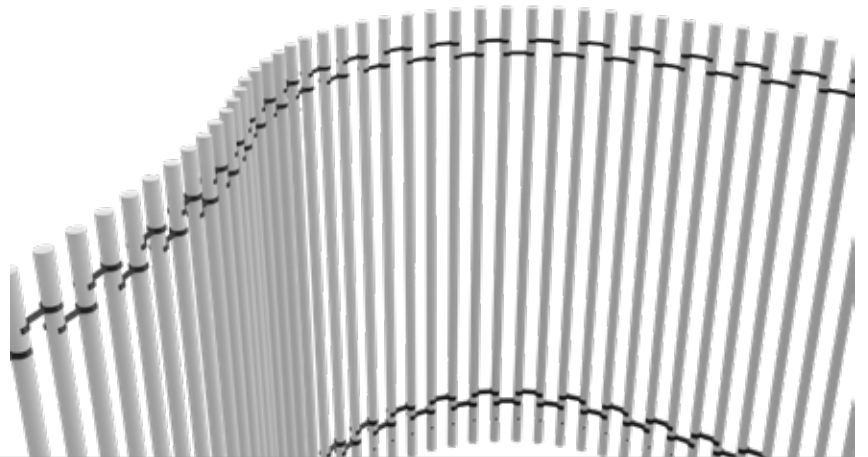

For grout in of pickets see following page!



PIK[®] OVERVIEW

OPTION 1

GROUT IN PICKETS IN CONCRETE RECESS

The top & bottom clip remain on the pickets when grout is poured. Once grout is set, the top clip is easily removed.

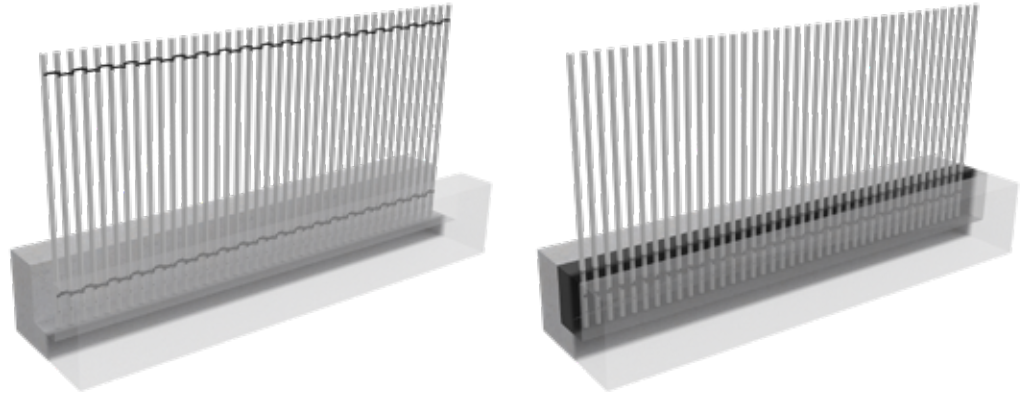

OPTION 2

CORE DRILL INDIVIDUAL PICKETS INTO EXISTING CONCRETE

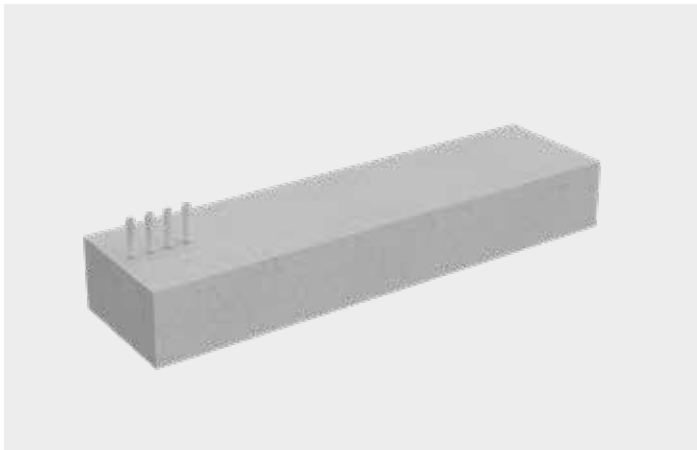

STEP 1

Use offcuts to determine PIK[®] position on concrete and mark on ground. Clip together offcuts to ensure accurate marking out/spacing. Use only a few offcuts and repeat marking out.

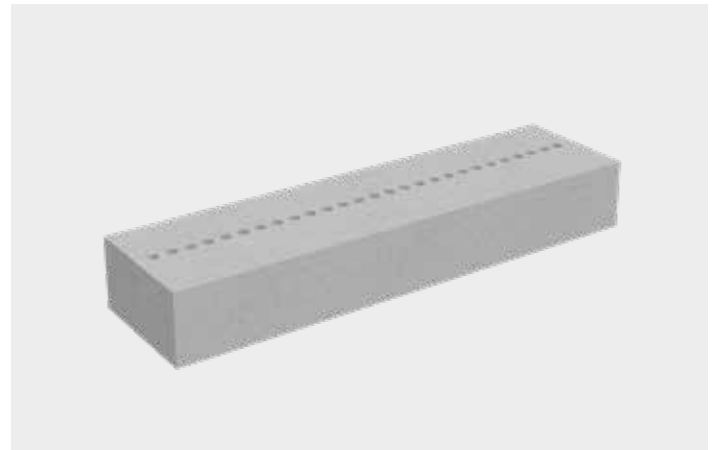

STEP 2

Core holes in concrete (suggest using a 42mm core bit).

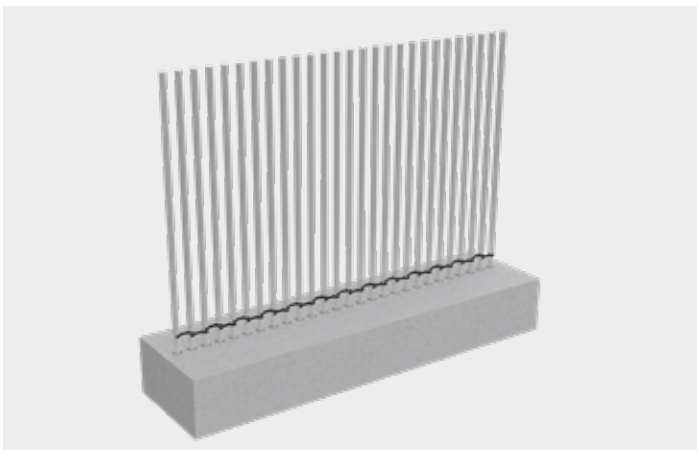

STEP 3

Set pickets to required height and grout in. Cut pickets to required height before setting in. *TIP: Clip on thin spacer clips at bottom to help with alignment. Thinner clip can be removed once grout sets. Thicker clip is hard to remove once installed.*



STEP 4

Completed.

PIK® FENCING

Gate

975mm W x 1200mm H
Satin Black or Pearl White finish

Order Code: **SC-11079 (Black)**
SC-11080 (White)

- Pedestrian access gate
- Made from aluminium for weight reduction versus steel
- 40x40mm full frame with 32mm round balusters
- 80mm baluster centres providing 48mm gaps
- Pool fence compliant to AS1926.1

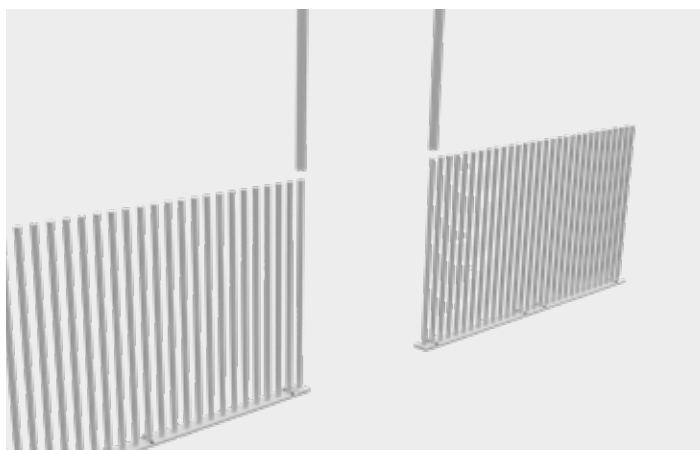
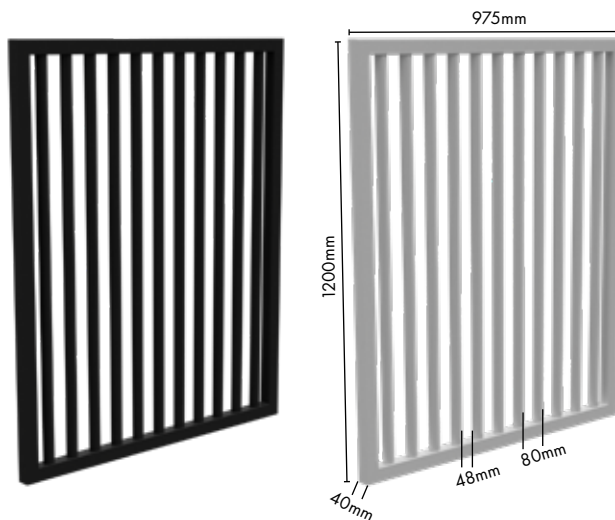

STEP 1

Sleave 40x40mm square profiles onto first and last pickets. (Ensure domical covers installed before square profiles).

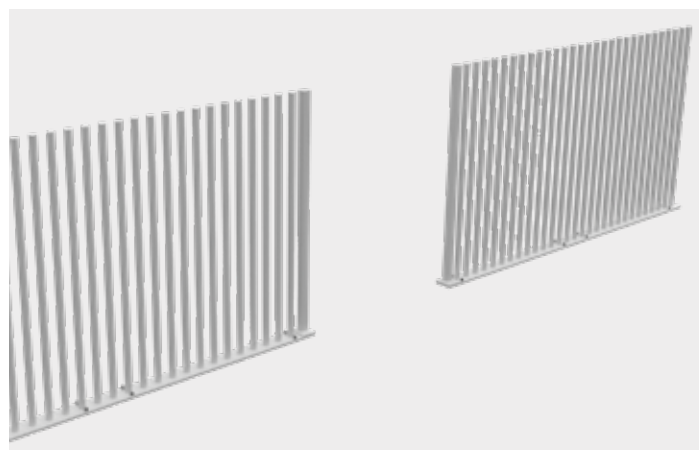

STEP 2

An opening is now created with square posts for hinging and latching of gate. ** suggest to leave a 'daylight' opening size of 1010mm (21mm hinge gap + 975mm gate + 14mm latch gap).



STEP 3

Use drill bit provided, drill through 40x40mm profile and 3mm wall of steel picket. Repeat for hinge and latch posts.

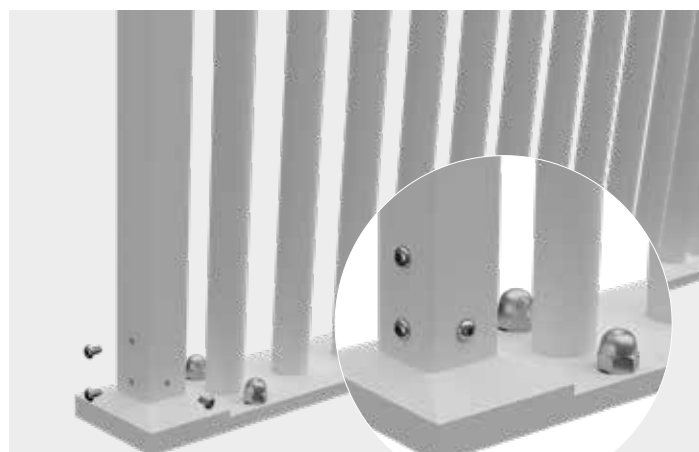

STEP 4

Drill 1 x hole on outer face of post and 2 x holes on inner face at bottom of post. Use self tapping screws provided and fix off screws. Repeat for hinge and latch posts.

PIK® FENCING

Gate Kit

Satin Black or Pearl White finish

Order Code: **SC-11081 (Black)**

SC-11082 (White)

KIT includes

- 2 X 40x40mm powder coated aluminium extrusion profiles 1257mm long
- 2 x top caps
- 2 x domical covers
- 6 x ST5.5x10 SS410 self tapping screws
- 1 x 5mm diameter drill bit
- Gate kit required when installing gate between PIK® fencing

Process of installation

- (1) Leave appropriate gap for PIK® gate between PIK® panels
- (2) Sleeve 40x40mm profile over adjacent final PIK® pickets create a HINGE and LATCH post
- (3) Once posts sleeved, fix off 40x40mm profiles to PIK® pickets with supplied fixings
- (4) Install gate between opening created

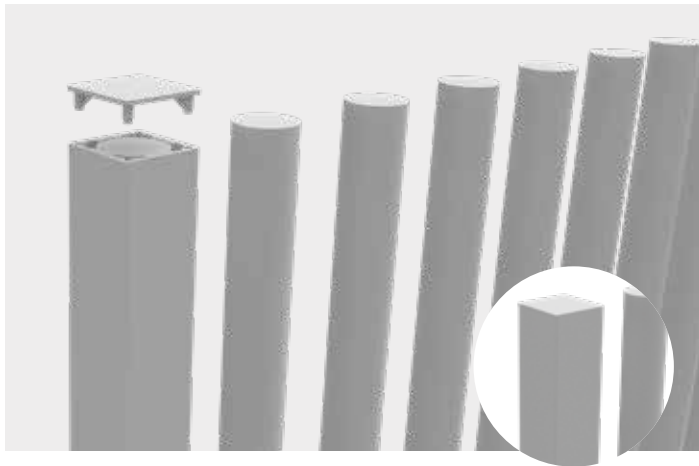
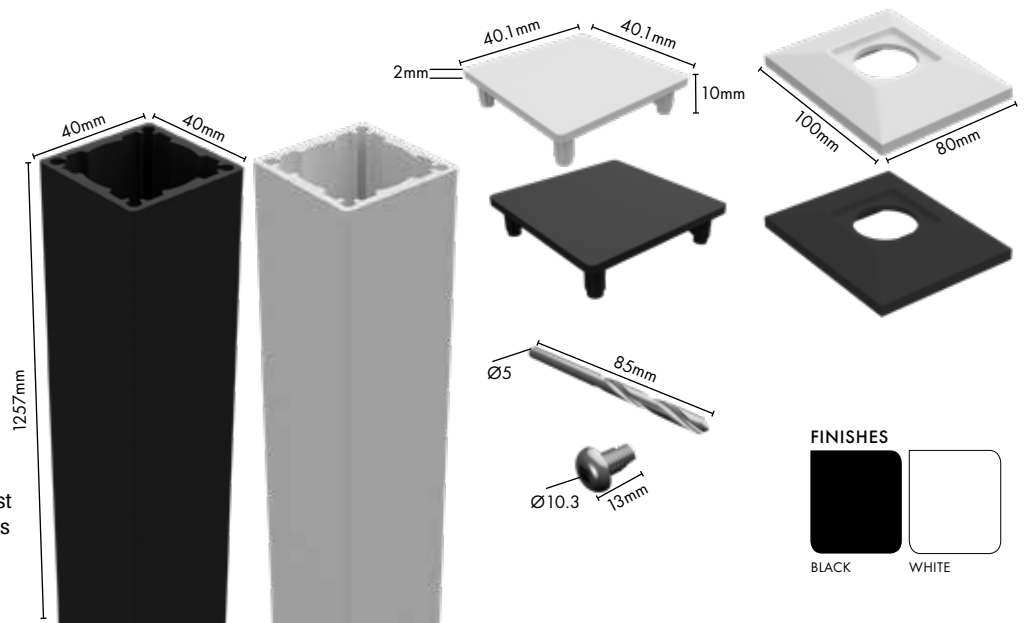

STEP 5

Fit top cap.



STEP 6

Install gate with hinges and top pull latch.
Completed.

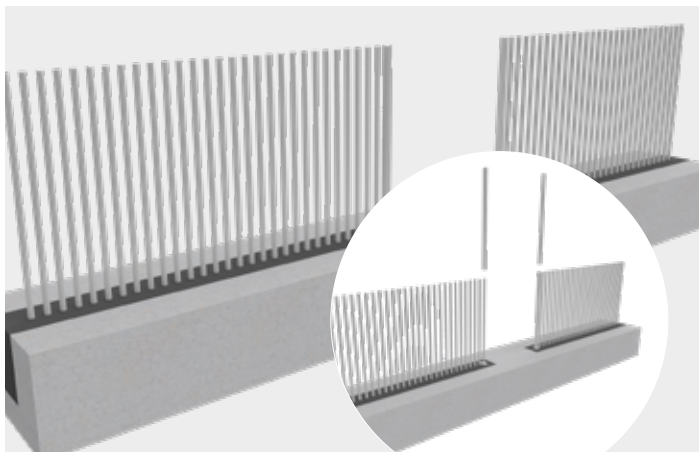

NOTE

The same installation methodology applies when pickets are grouted in. The 40x40mm profiles will require cutting to required height (use appropriate cutting blade to cut aluminium profiles).

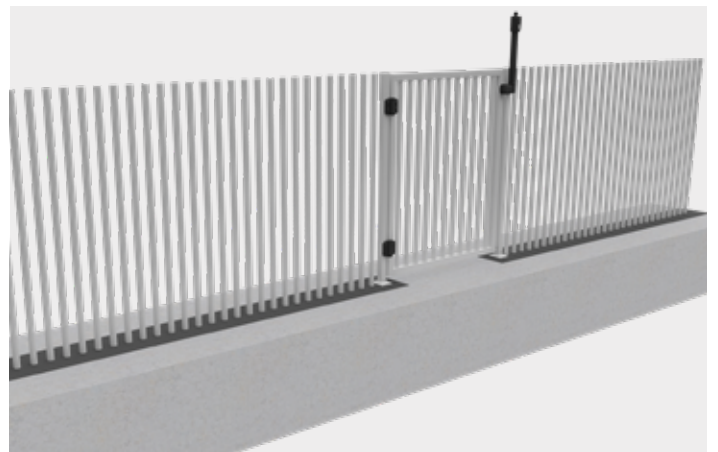

Completed.

PIK® FENCING

M16 x 100mm Threaded Rod Kit

SS304 – 4 PACK

Order Code: **SS-110069**

- M16 threaded rod: 100mm long
- Pack of 4
- Optional extra for use if plinth is buried in grout and extra anchoring desired
- Each 1200mm wide plinth/panel has 4 x threaded nutserts on its underside
- M16 rods thread into the nutserts and protrude downwards 100mm providing extra anchoring in grout.

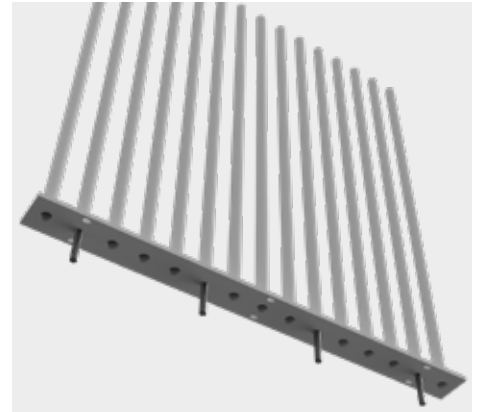
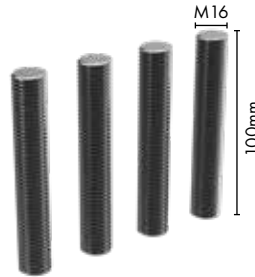

400mmL Base Extender Picket

PACK OF 4

Satin Black or Pearl White finish

Order Code: **SC-11076 (Black)**

SC-11077 (White)

- Pack of 4
- 32mm diameter picket extender with 20mm thread at top
- 400mm long picket made from galvanized steel with epoxy base coat & then powder coated
- Each 1200mm wide plinth/panel has 4 x threaded nutserts on its underside
- M16 thread at top of extender threads into nutsert enabling 400mm long extender to protrude downwards
- Use if extra anchoring required for plinth/panel installation into ground/grout/concrete
- Also may be used where plinth extends over a void/drop and an 'extrusion pillar' is required under the plinth.

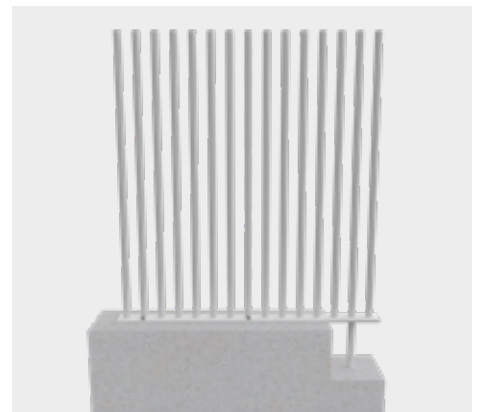
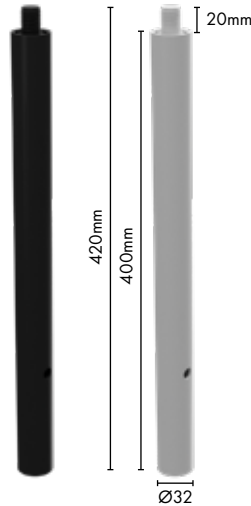

FINISHES



BLACK

WHITE

PIK® FENCING

32mm Diameter Round Top Cap

5 PACK

Black or white finish

Order Code: **SC-11070 (Black)**

SC-11071 (White)

- 32mm diameter UV stable nylon top cap
- Pack of 5
- Presses into top of picket
- Top caps are supplied as standard with PIK® panels. Caps sold separately if needed for replacement or if extras required.

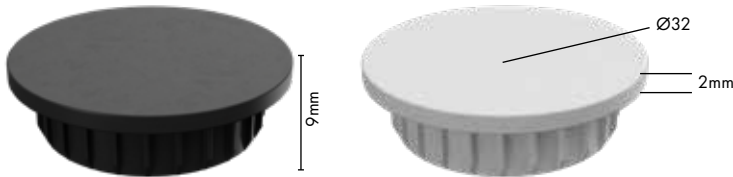

FINISHES



BLACK

WHITE

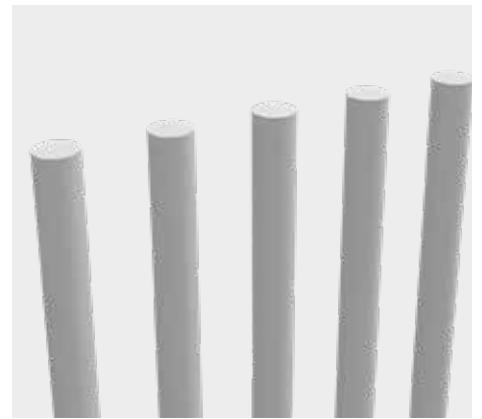
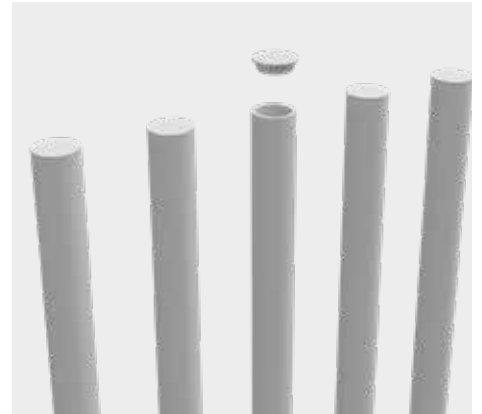

PIK® Dress Ring

Satin Black or Pearl White finish

Order Code: **SC-11074 (Black)**

SC-11075 (White)

- 33.5mm inner diameter
- 50mm outer diameter
- 2mm thickness
- Consider using dress rings where pickets are individually core drilled
- Powder coated aluminium

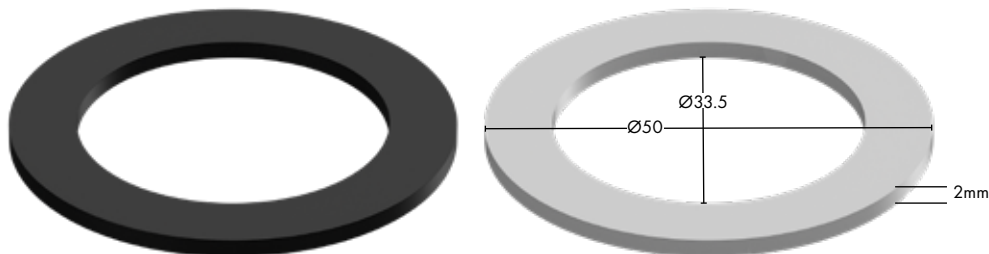

FINISHES

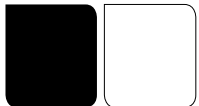

BLACK

WHITE

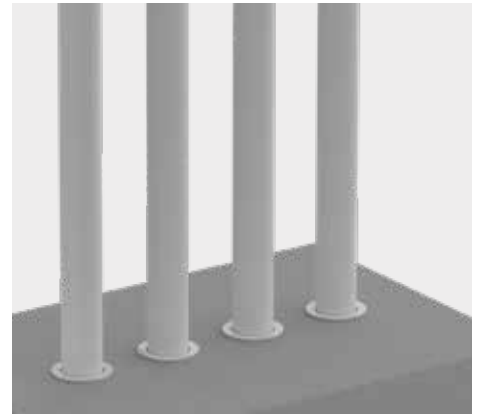

PIK® FENCING

Base Joiner

5 PACK

Black nylon

Order Code: **SC-11083**

- Pack of 5
- Plastic joiner that fits to 4 x pickets
- Recommended for use with installation of 1200mm wide PIK® panels with plinth (code: PIK-PNL-1200-1280).
- Clip joiner onto 2 x pickets from 1 x panel and onto 2 x pickets of joining panel. The joiner keeps adjacent panels in alignment and prevents chance of spreading panel when installing
- For surface mount installation, remove joiner clip after installation
- For grout-in installation, joiner may remain in place and be buried

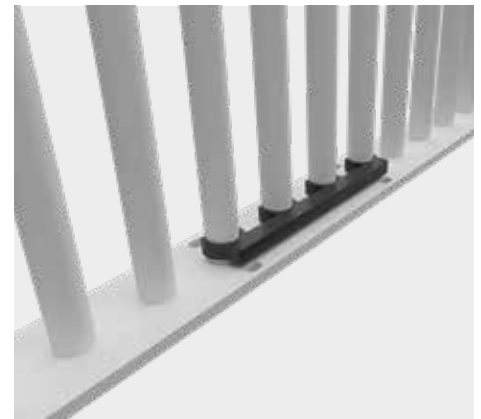
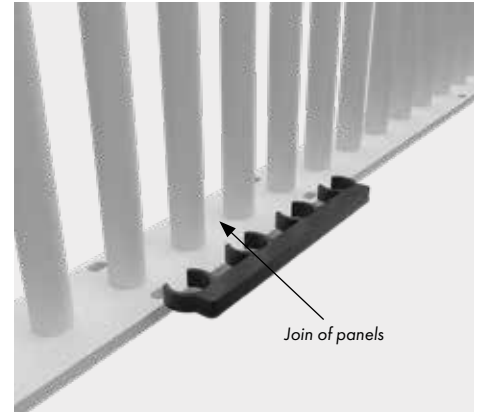

TRADE TIP

A 'Base Joiner' is highly recommended to help alignment with several PIK®'s. It will ensure the spacing between each PIK® is exact and spacing remains pool compliant.

FINISHES



BLACK

18.8 x 12.8mm Plug for Base Plate

10 PACK

Black or White finish

Order Code: **SC-11084 (Black)**
SC-11073 (White)

- Pack of 10
- Oval shape UV stable plastic plugs that suit plugging of holes in plinth
- Each 1200mm wide plinth has 6 x oval shape fixing holes for surface mount installation
- If not all fixings holes are used, oval plugs can be inserted to fill gap of unused fixing holes

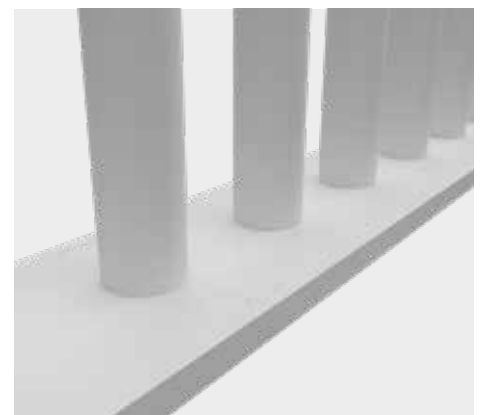
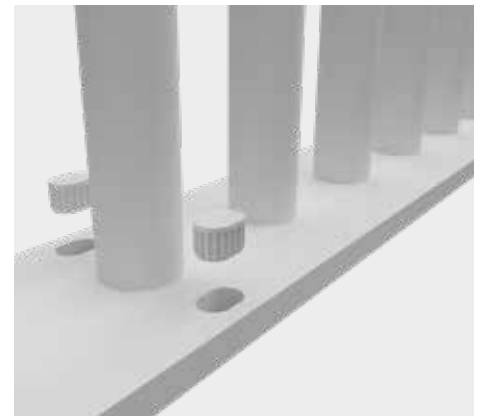
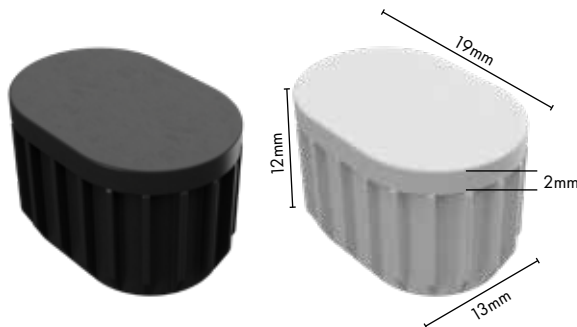

FINISHES



BLACK

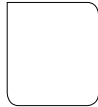

WHITE

PIK® FENCING

PIK® Lever

Order Code: **SC-11078**

- 400mm long plastic lever
- Aids in alignment of PIK® vertical balusters.
- After installation, the top of vertical pickets may appear slightly out of alignment.

To re-align

- (1) carefully remove top cap in picket
- (2) insert lever into top of picket
- (3) bend picket to achieve alignment
- (4) remove lever, and
- (5) reinsert top cap once alignment complete

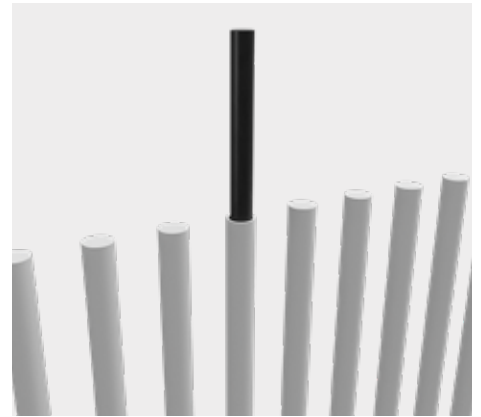
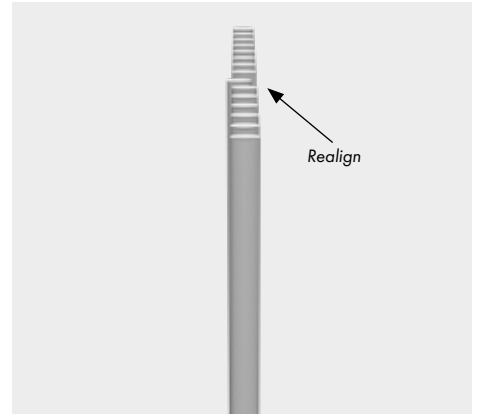

FINISHES



BLACK



EXTRAS & ACCESSORIES

M12 dome nut

PACK OF 4 – SS316

Black or Silver finish

Order Code: **GS-DN-4PK-B (Black)**
SC-1604 (Silver)

- 4x dome nuts & 4x split washers
- Suits M12 thread
- Fixing option for surface mount installation of PIK® panels or with plinth in conjunction with M12 threaded rod or lag screws

Silver recommended for white powder coat installations. Black recommended for black powder coat installations.



FINISHES



MATT BLACK SILVER

M 12 FIXINGS

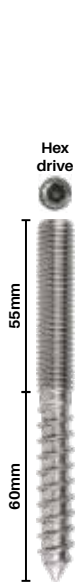

115mm lag screw

SS304

M12 thread

Order Code: **SC-1202**

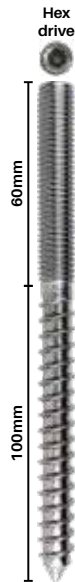

160mm lag screw

SS304

M12 thread

Order Code: **SC-1203**

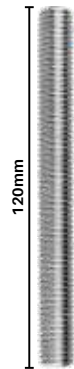

120mm threaded rod

SS304

M12 thread

Order Code: **SC-1198**

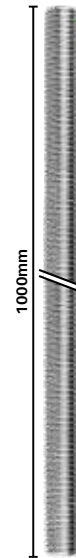

1000mm threaded rod

SS304

M12 thread

Order Code: **SC-1197**

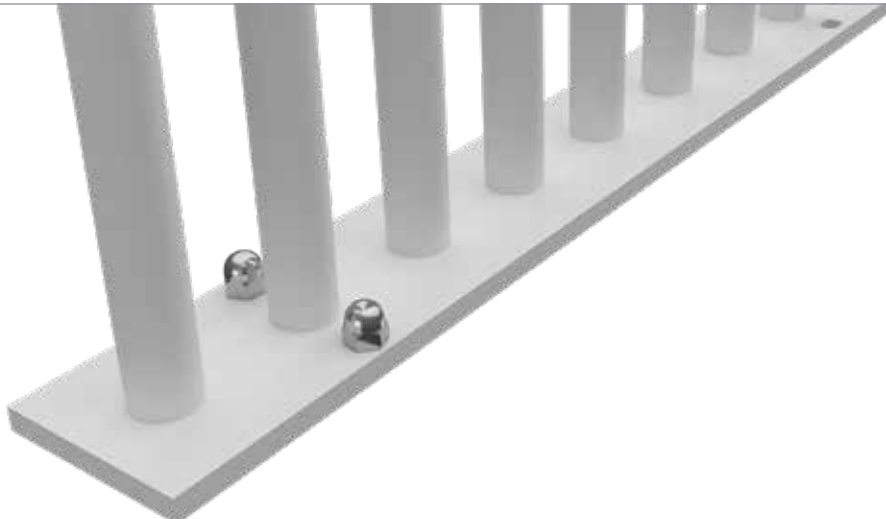

EXTRAS & ACCESSORIES



Soudafix CA1400 Chemical anchor

280mL

Order Code: **SC-1599**

- High performance, two-component chemical anchoring resin for the pressure-free securing of anchoring rods, studs, threaded collars etc
- Easy to use and apply
- Fast cure (20°C=45min full cure; 30°C=25min full cure)
- Vinylester styrene free
- Can be used in damp concrete
- Apply with standard caulking gun



Soudal heavy duty cartridge gun

Order Code: **SC-1600**

- Heavy duty, steel trade quality cartridge gun
- Geared ratio 18:1 for smooth operation and easy application
- Dripless system feature automatically releases pressure to reduce mess/waste
- Suits 300ml silicone cartridges and 280ml chemical anchor

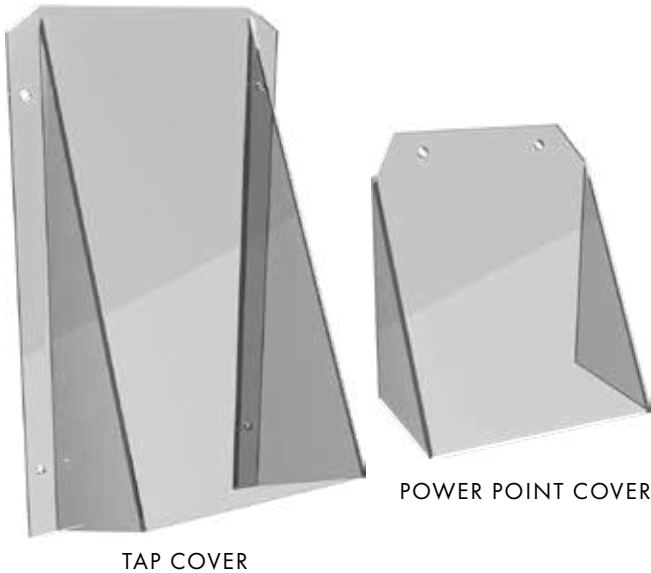

TAP COVER

POWER POINT COVER

Toe hold prevention covers

THERMOPLASTIC

Transparent finish

Order Code: **SC-1139 (Power point cover)**
SC-1140 (Tap cover)

- Transparent thermoplastic
- Cover features 60 degree angle to prevent a toe hold
- Ideal solution if tap or power point considered a step point
- Resistant to impact & chemicals
- Power point cover comes with 2 x predrilled fixing hole
Includes 2 x SS316 screws (ST5x40mm) & 2 x wall plugs
- Tap cover comes with 4 x predrilled fixing hole
Includes 4 x SS316 screws (ST5x40mm) & 4 x wall plugs

TAP COVER SPECIFICATION

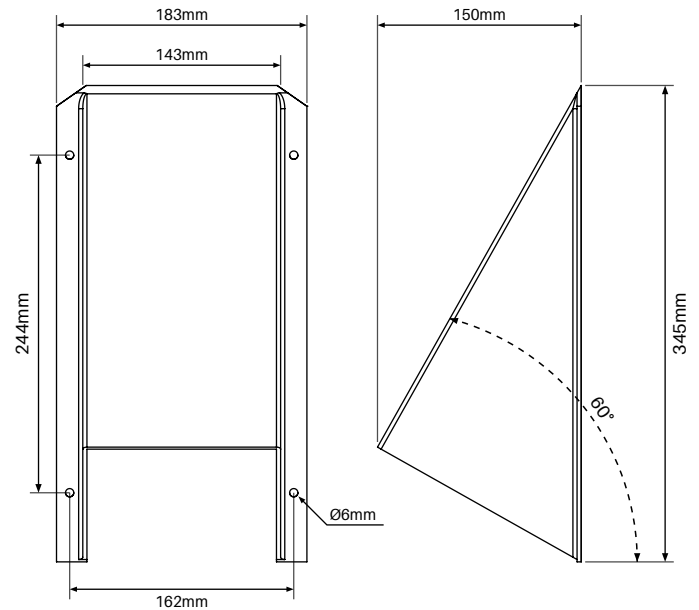

POWER POINT COVER SPECIFICATION

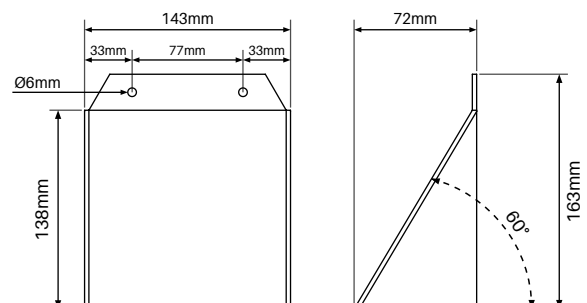

TRADE TIP

PIK® can also be an attractive fencing solution, offering an architectural style boundary alternative.



EXTRAS & ACCESSORIES

Horseshoe packers

20 PACK

Black finish

Order Code:

SC-3733

1mm thick

SC-3734

3mm thick

- 38mm wide x 75mm long horseshoe packers
- 10.5mm slot
- Available in 1mm or 3mm thick (20 per pack)
- Durable black solid polypropylene
- Handy for levelling adjustments while installing
- Easy to cut down to required length

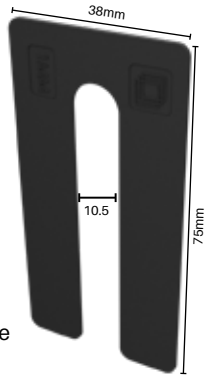

Available 1mm or 3mm thick

Touch up paint

150g SPRAY CAN

Black & white

Order Code:

SC-1420-BLK

SC-1423-WH

- Colour match touch up paint
- Simply spray on for minor touch ups



CPR sign

Order Code: **SC-1142**

- Genuine royal life saving society – Australia resuscitation chart
- Plastic coated for durability



Square head driver bit

Order Code: **SC-2656**

- Driver bit to suit 3.4mm square screw head hole
- Use for fixing off gate kit screws (refer code PIK-GATEKIT-B/W)



Polaris grout

10kg bag

Order Code:

PA-7863

- Non shrink grout
- Rapid setting
- Aggregate free



Bostik HES grout

20kg bag

Order Code: **SC-1619**

- Non shrink grout
- High early strength



Sika HES grout

20kg bag

Order Code: **SC-10168**

- Non shrink grout
- High early strength



Rapid set concrete

20kg bag

Order Code: **RSC020**

- For Perth depot, refer code GROUT-KWIKSET
- Specially formulated to harden rapidly
- Just add water



Concrete mix

20kg bag

Order Code: **PMC020**

- Quality blend of GP cement, aggregate & sand – just add water
- Ideal for high strength concreting of posts



Perth only

KWIKSET concrete

20kg bag

Order Code: **HB-4503**

GATE LATCHES & HINGES

HINGE GAP – 20-22mm
LATCH GAP – 13-38mm



Magna Latch® with Tru Close® hinge pair

ADJUSTABLE TENSION

Order Code: **ML-TL-TC-H-AT (Single)**

D&D code: MTSTDKS3LA

- Kit includes D&D top pull Magna latch and 2x TRU close hinges
- Patented tension adjustable hinges (TC-H-AT-B version hinges – no alignment legs on hinges provides for flexible installation)
- Pool fencing compliant – Rated to 30kg self close
- Magnetically triggered lockable latch

• BULK BUY CARTON QTY: 15PCS

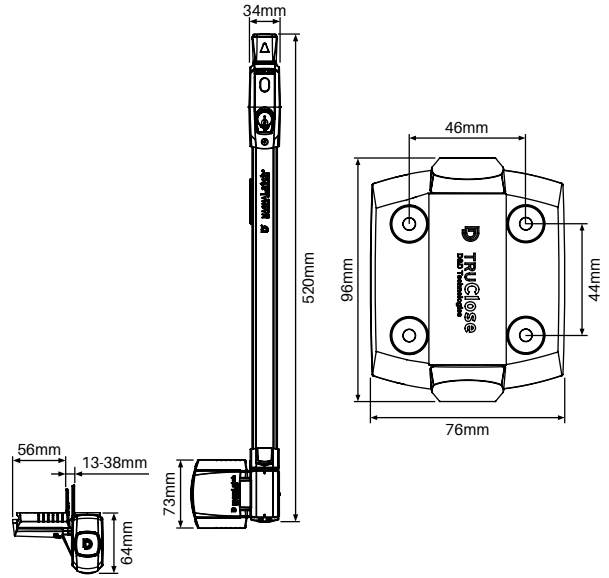

13-38mm
gap spacing



Top pull lockable latch

Order Code: **ML-TL-W (Single white)**
ML-TL (Single black)

- Magnetically triggered lockable latch
- Improved stylish "Series 3" design
- Adjusts horizontally and vertically
- Includes adjustable striker plate
- D&D Limited lifetime warranty
- Quick and easy installation
- Tested to over 400,000 cycles

• BULK BUY CARTON QTY: 15PCS

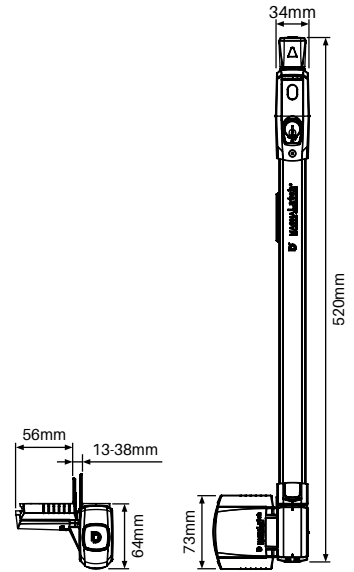

PLEASE NOTE

Hinges and latches featured are suitable for PIK® system installed when pool fencing compliance required.

A full range of other hinge and latching options is available in the 'Fencing & Breezewire' catalogue.



GATE LATCHES & HINGES

21 mm
gap spacing

2
alignment legs



TruClose® hinge pair

2 ALIGNMENT LEGS

Order Code: **SC-1815 (Black)**
SC-2099 (White)

- D&D patented tension adjustment
- Strong, moulded polymer and stainless steel
- Adjust tension from both ends of the hinge
- No visible fixings
- Super strong engineering polymers and stainless steel components
- Won't rust, bind, sag or stain
- Limited lifetime warranty
- White polymer
- Pool fencing compliant - Rated for **gates up to 30kg**

Two alignment legs on hinge allows for quick, easy and accurate positioning of gate onto post

*BULK BUY CARTON QTY: 20 PAIRS

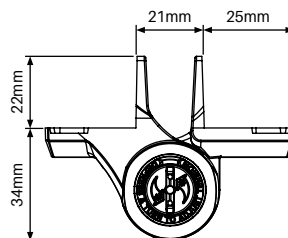
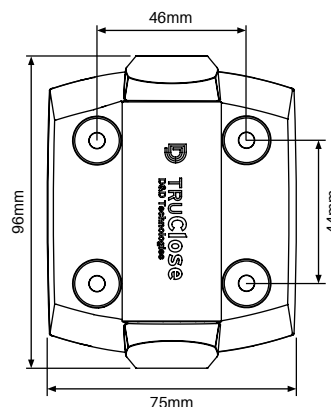

Reinforcing ribs
Moulded ribs provide super strength

Patented adjuster
Easy tension adjustment

Concealed fasteners
Trim covers hide the fasteners to improve the appearance of the gate



Internal stainless steel spring
Won't rust or corrode

Moulded hinge body
Engineering polymers with glass fibre reinforcement are UV stabilised



Certi cap – Series 3

Order Code: **TC-CAP53**

D&D code: TCACAP53

- Prevents toe hold on hinge
- Durable polymer material

EXTRAS & ACCESSORIES

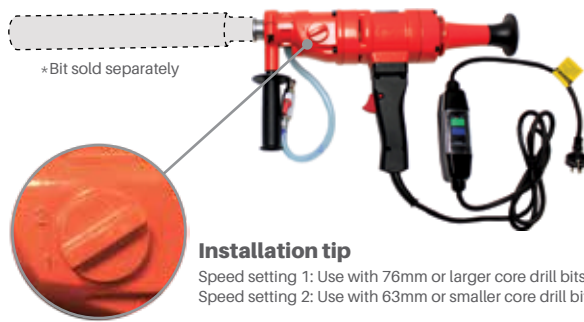

Installation tip

- Speed setting 1: Use with 76mm or larger core drill bits
- Speed setting 2: Use with 63mm or smaller core drill bits

Diamond revolution drill

Core drill

Order Code: **SC-10088**

- 2 speed core drill - 1500W
- Comes with case, allen key, spare set of brushes and manual
- Safety switch
- Uses common size 1 1/4" UNC male thread for diamond core bits

Technical data

Voltage: 240V

Rated frequency: 50-60Hz

Rated input power: 1500W

No load speed r/min: 2100/950

Weight: 8.8kg



Diamond revolution stand

Suits diamond revolution core drill

Order Code: **SC-10011**

- Steel and aluminium construction
- Height: 800mm
- Base: 330mm x 380mm
- Weight: 12.6kg



Core drill template

Order Code: **SC-1603**

- Assists with starting to core drill hole
- Stabilises the drill bit from jumping



Spirit level for core drill

Order Code: **SC-10105**

- Screws into core drill machine
- Assists with drilling accurate holes



Splash guard/ water trap

Order Code: **SC-10112**



Base for stand

Order Code: **SC-11166**

- 550mm x 550mm overall dimensions

Core drill bits

Mild steel body & diamond impregnated crown tip



8mm mini core drill bit

Order Code: **SC-1161**



10mm mini core drill bit

Order Code: **SC-1605**



12mm mini core drill bit

Order Code: **SC-1606**



14mm mini core drill bit

Order Code: **SC-1607**



20mm mini core drill bit

Order Code: **SC-1608**

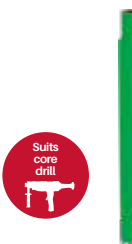

42mm core drill bit

42mm x 450mm long

Order Code: **REV-BIT-42**



53mm core drill bit

53mm x 450mm long

Order Code: **SC-1147**



63mm core drill bit

63mm x 450mm long

Order Code: **SC-1148**



76mm core drill bit

76mm x 450mm long

Order Code: **SC-10080**



83mm core drill bit

83mm x 450mm long

Order Code: **SC-1609**



89mm core drill bit

89mm x 450mm long

Order Code: **SC-1610**

ORDER CODES



Order Code	Description	Colours
SC-11067 / SC-11068	Panel – 1200mm W x 1280mm H	
SC-11063 / SC-11064	90 degree curved corner panel – 1000mm W x 1000mm D x 1280mm H	
SC-11065 / SC-11066	Kit in a box – 10 pack of 1600mm H pickets	
SC-11079 / SC-11080	Gate – 975mm W x 1200mm H	
SC-11081 / SC-11082	Gate kit – 40 x 40mm profiles x 2	
SS-110069	M16 x 100mm threaded rod kit – 4 pack	
SC-11076 / SC-11077	400mm L base extender picket – 4 pack	
SC-11070 / SC-11071	32mm diameter round top cap – 5 pack	
SC-11074 / SC-11075	Dress ring – 50mm outer diameter	
SC-11084 / SC-11073	18.8 x 12.8mm plug for base plate – 10 pack	
SC-11078	PIK® lever	
SC-11083	Base joiner – 5 pack	

INSTALLATION OVERVIEW

OPTION 1A – WELDED PLINTH – BOLTED TO FLOOR

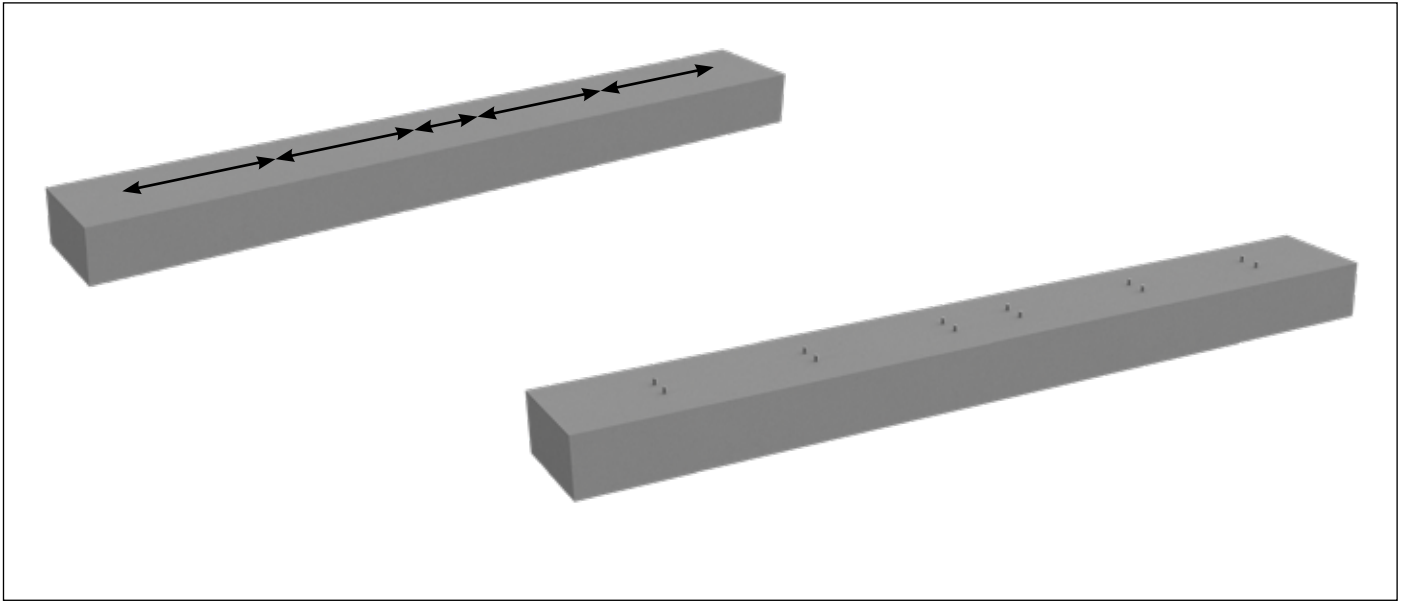

- 1 Measure and mark out panel positions on concrete substrate.
Install M12 threaded rods into floor making use of the 6 x slotted holes on plinth base plate.
Threaded rods should protrude 16-20mm from surface.
NOTE: Fixtures not supplied, ensure use of M12 fixings with regard to base substrate.

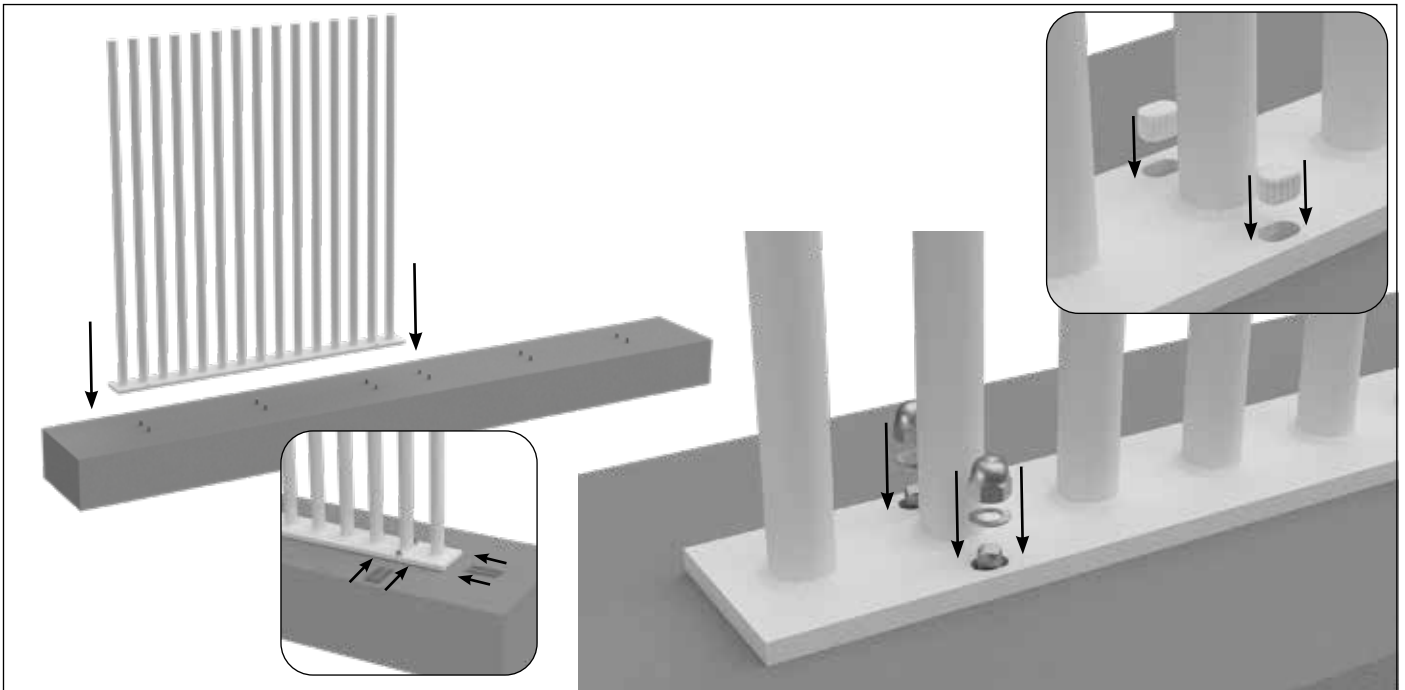

- 2 Once all threaded rods are set in position, position PIK Panel over threaded rods and secure in position with split washers and dome nuts. For unlevel surfaces, ensure the use of horse shoe packers to achieve a level installation.
TRADE TIP: Unused slots, due to hole repositioning, can be filled using Base Plate Plugs to give a flush base plate finish.
IMPORTANT: Consider earthing requirements.

INSTALLATION OVERVIEW

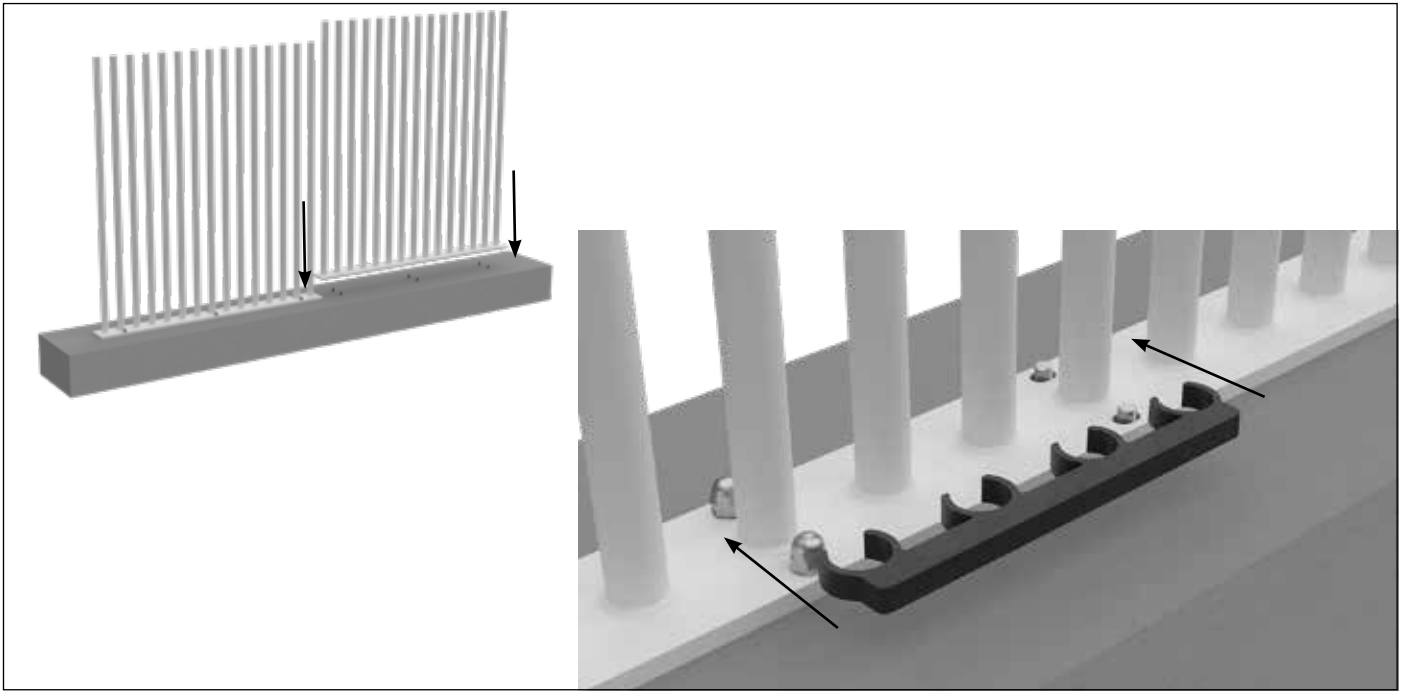

- 3** Position adjacent panel next to first panel. Snap on a base joiner to the adjoining 2 pickets of each panel to assist with aligning the panels.

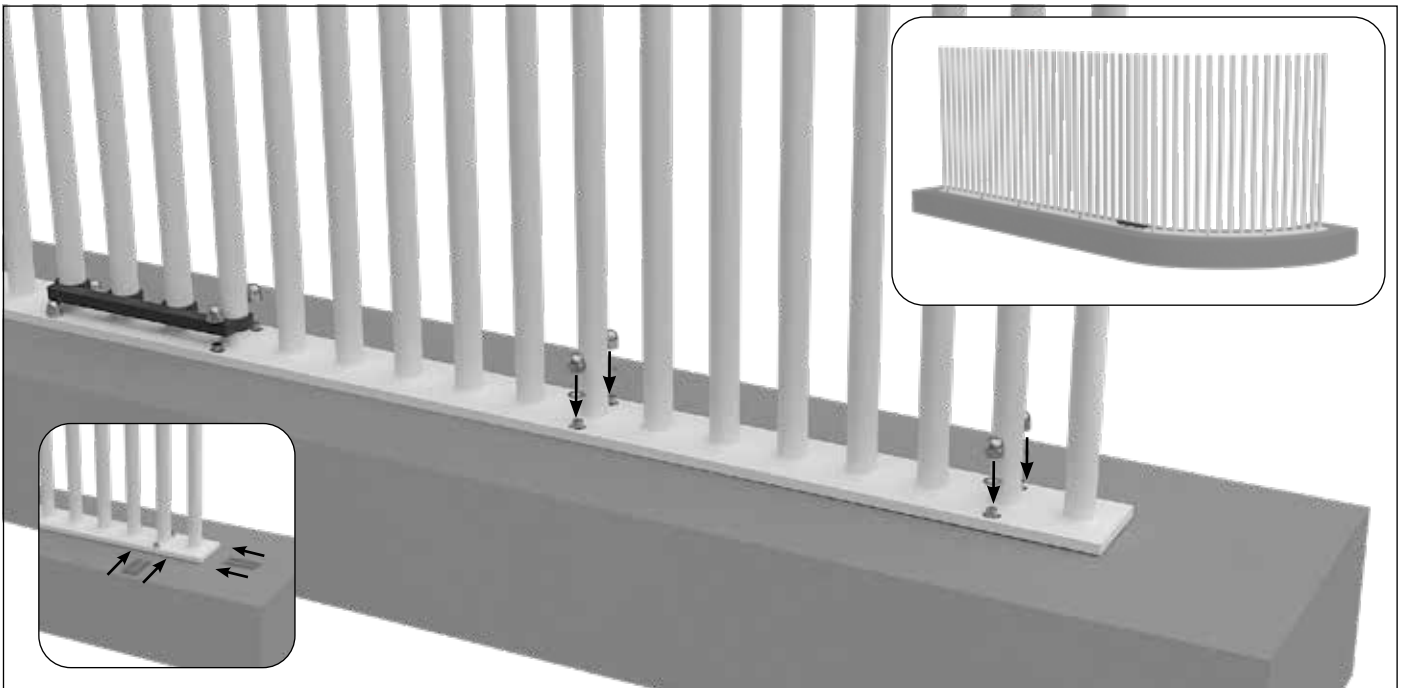

- 4** Secure panel with split washers and dome nuts. For unlevel surfaces, ensure the use of horse shoe packers to achieve a level installation. Remove base plate joiner.
 Repeat process for remaining panels including 90° corner panels. 90° corner panels butt-up against straight panels to give correct picket spacing.

INSTALLATION OVERVIEW

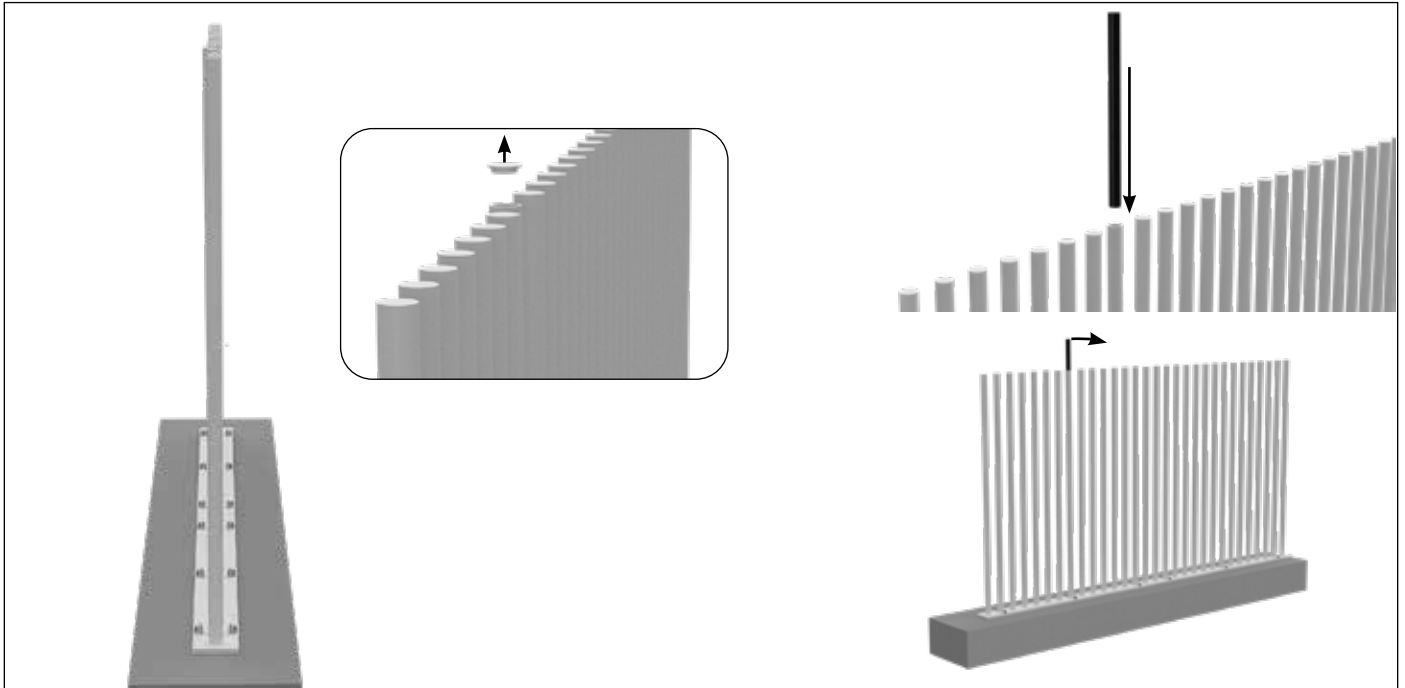

● **TRADE TIP:** For the slight adjustment of any pickets that are not in-line, remove top cap and insert PIK Lever into top of post. Carefully Bend picket back into position. Replace top cap.

INSTALLATION OVERVIEW

OPTION 1B – WELDED PLINTH – GROUTED-IN

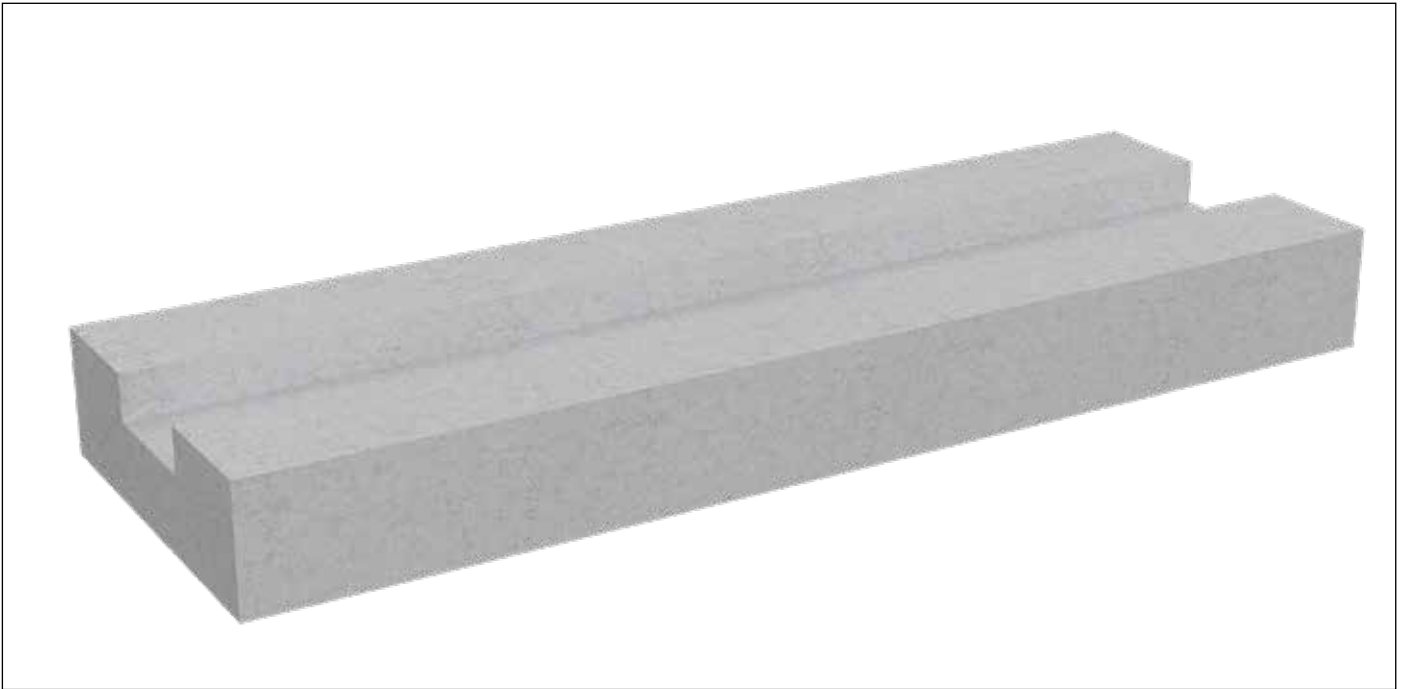

A Create a channel in the concrete slab.

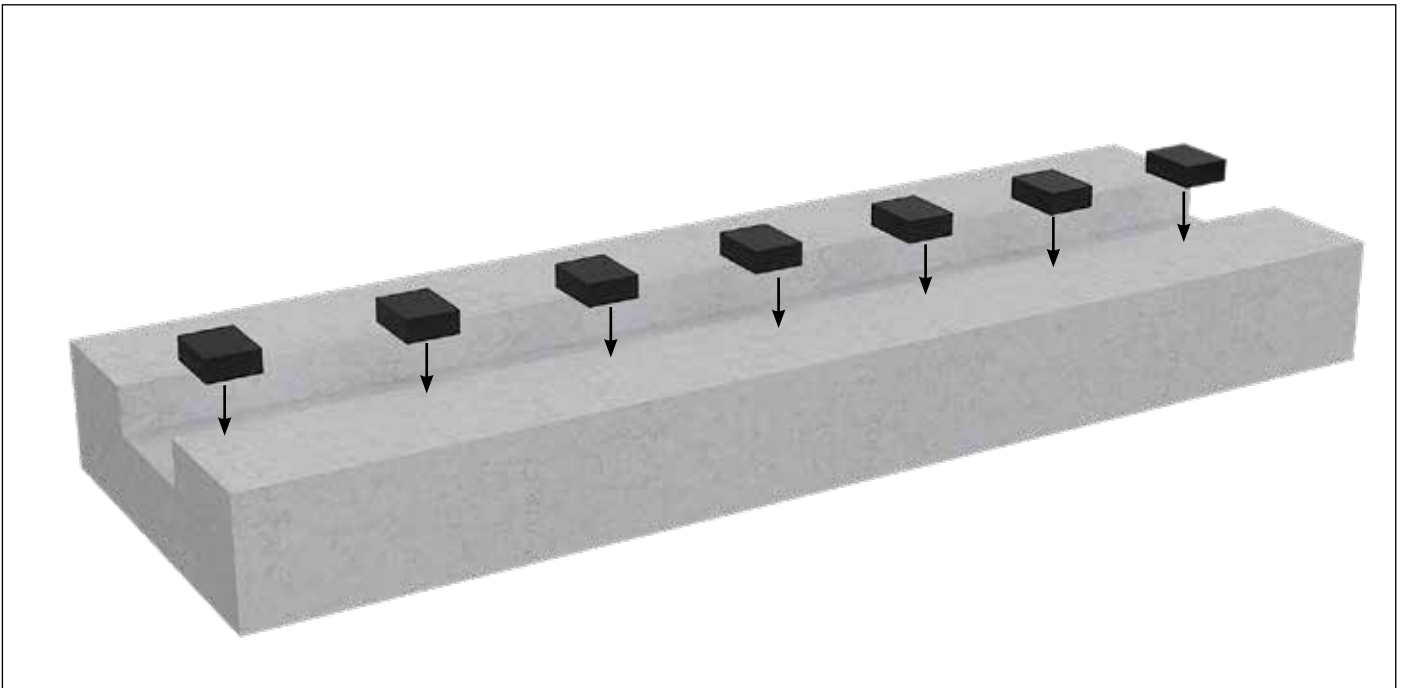

B Insert plastic blocks, or the like, for the welded plinth to sit on.

IMPORTANT: For pool fence or gate applications, ensure the pickets sufficiently protrude from the finished slab line.

INSTALLATION OVERVIEW

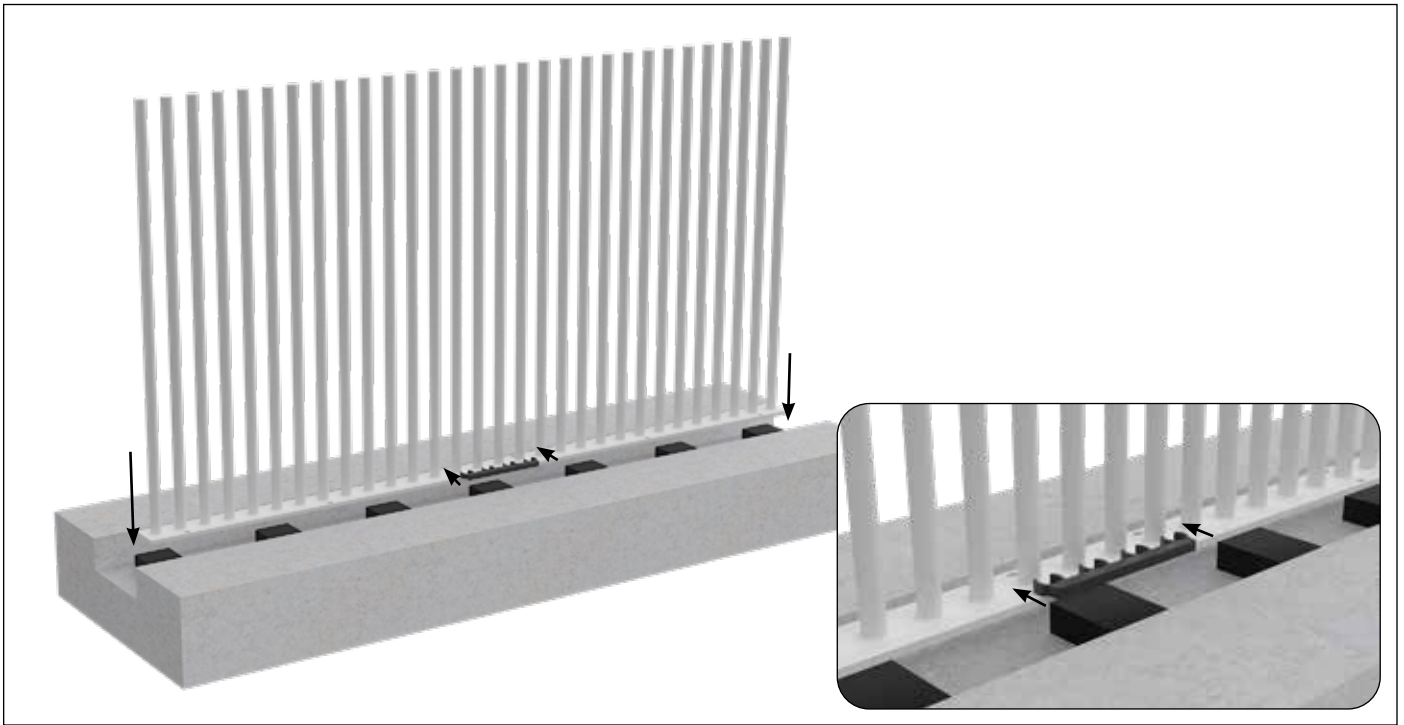

- C** Place panels on the blocks and clip together at the bottom using a base joiner. Ensure panels are level.
IMPORTANT: Consider earthing requirements.

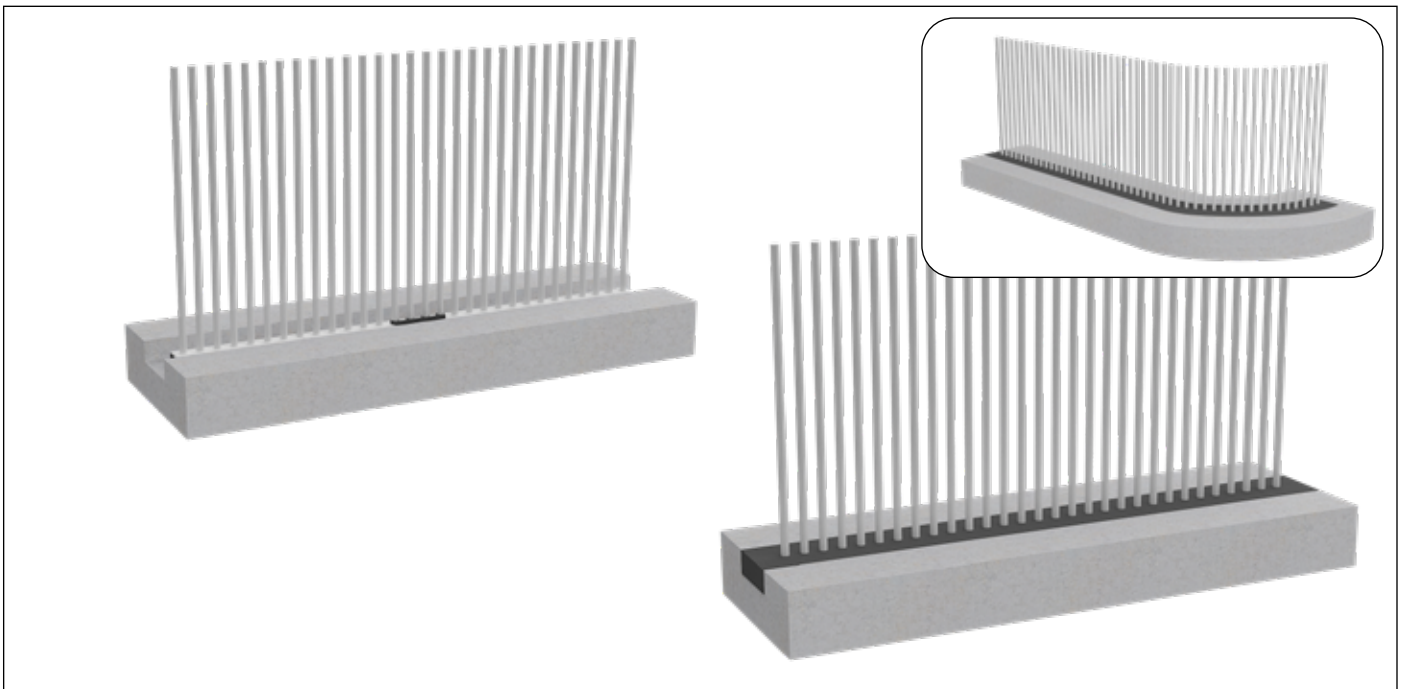

- D** Grout panels into position. The base joiner can remain in position when grouting, ensuring it is below the finished slab line.
Repeat process for remaining panels, including 90° corner panels

INSTALLATION OVERVIEW

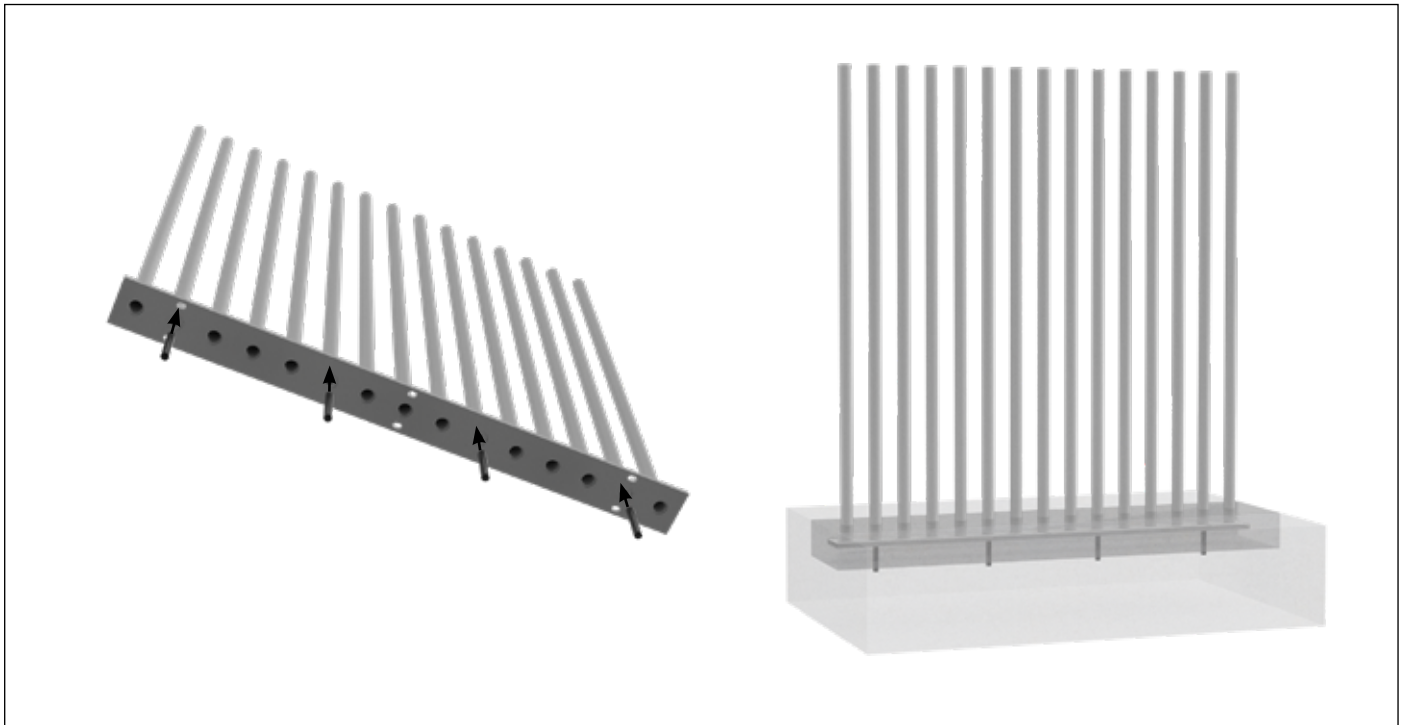

TRADE TIP: For extra purchase within the channel, consider using M16 threaded rods in the 4 x threaded inserts on the underside of each panel to anchor the panel deeper into the ground.

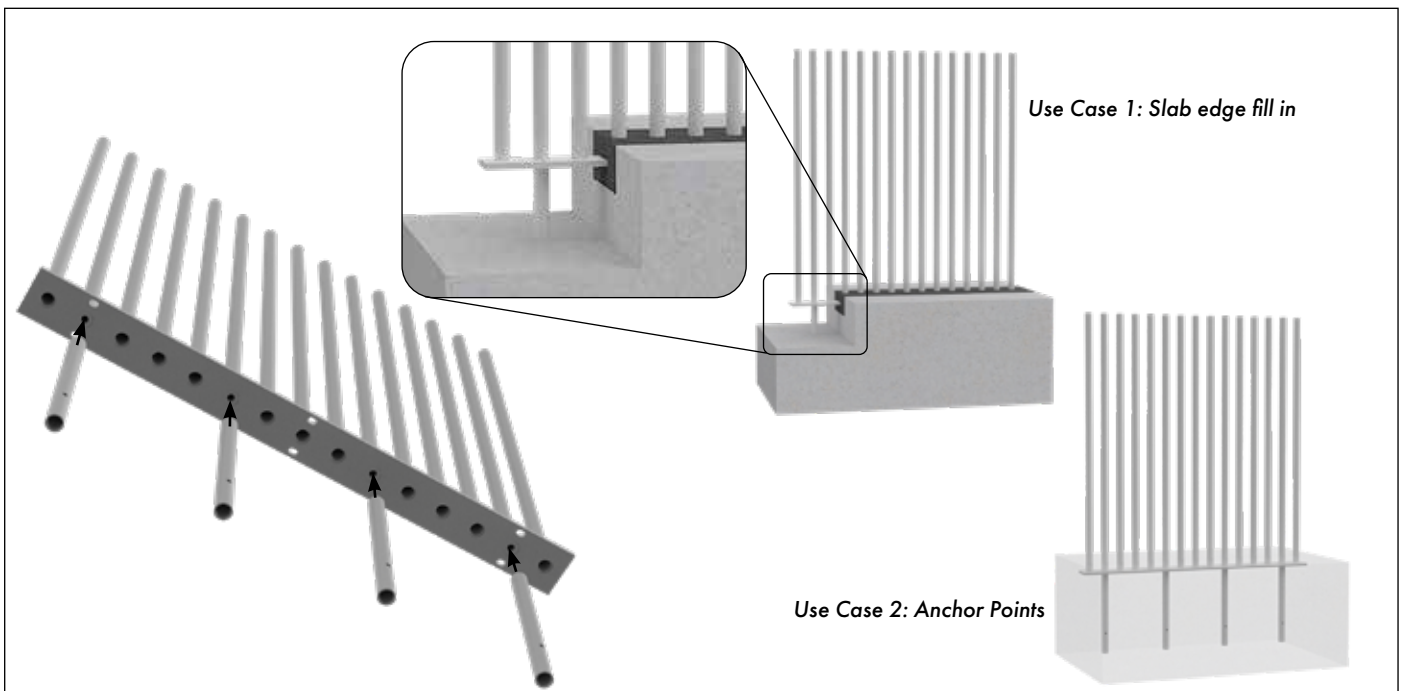

TRADE TIP: When the PIK panel extends over a slab edge, 400mm Base Extender Pickets can be inserted into the threaded inserts on the underside of PIK Panels to fill the gap and/or help anchor the panel in position with deeper earth embedment.

INSTALLATION OVERVIEW

OPTION 2A – KIT IN A BOX – GROUTED-IN



i Mark out, measure and dig or create a channel in ground at least 300mm wide, 600mm deep. (Consider differing soil types)

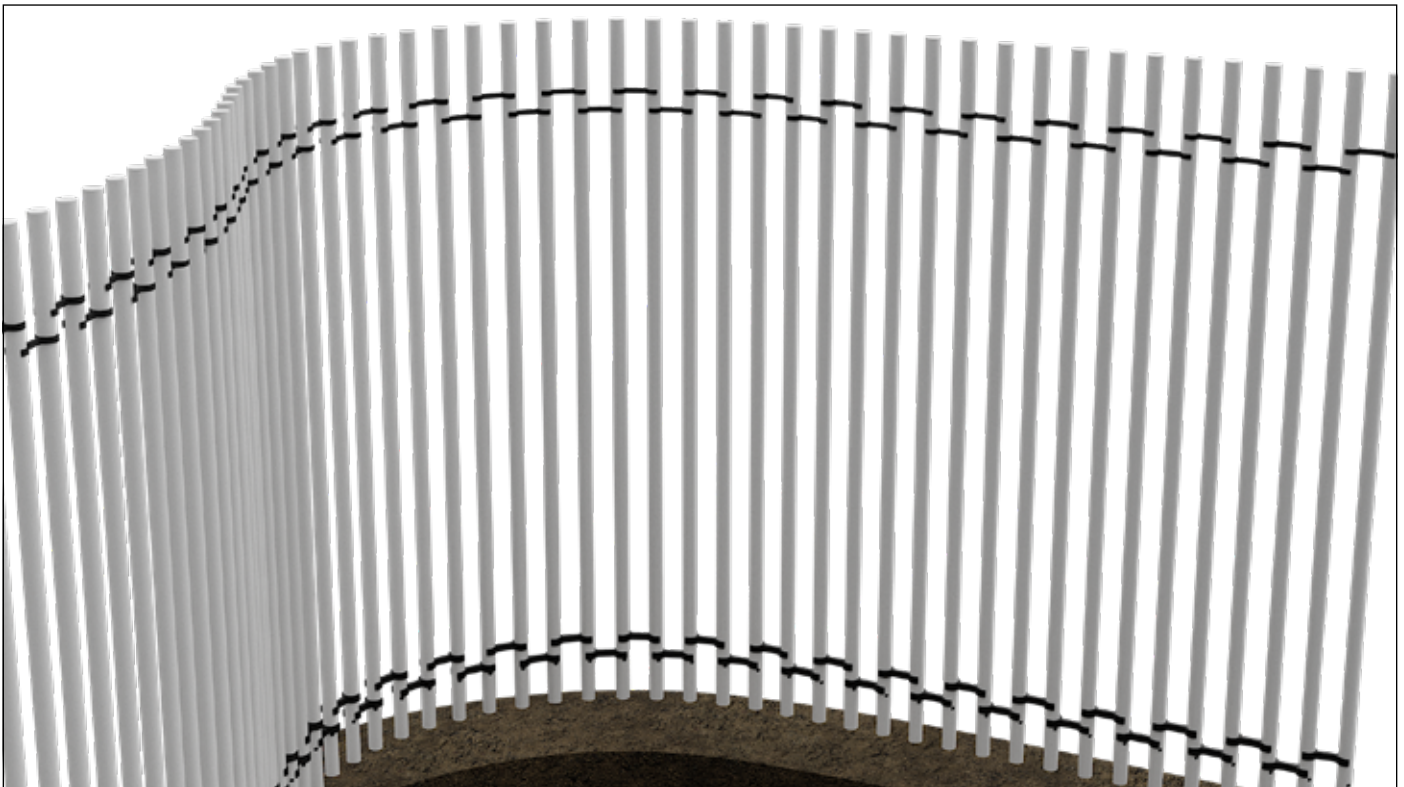

ii Position pickets in ground using bottom clips at the base of the pickets, under ground level, and top clips near the top of the pickets. Clips ensure correct spacing and help to hold pickets in position when used in organic shapes, curves etc.

NOTE: Bottom picket clips remain in place when grout is poured.

IMPORTANT: Consider earthing requirements.

INSTALLATION OVERVIEW

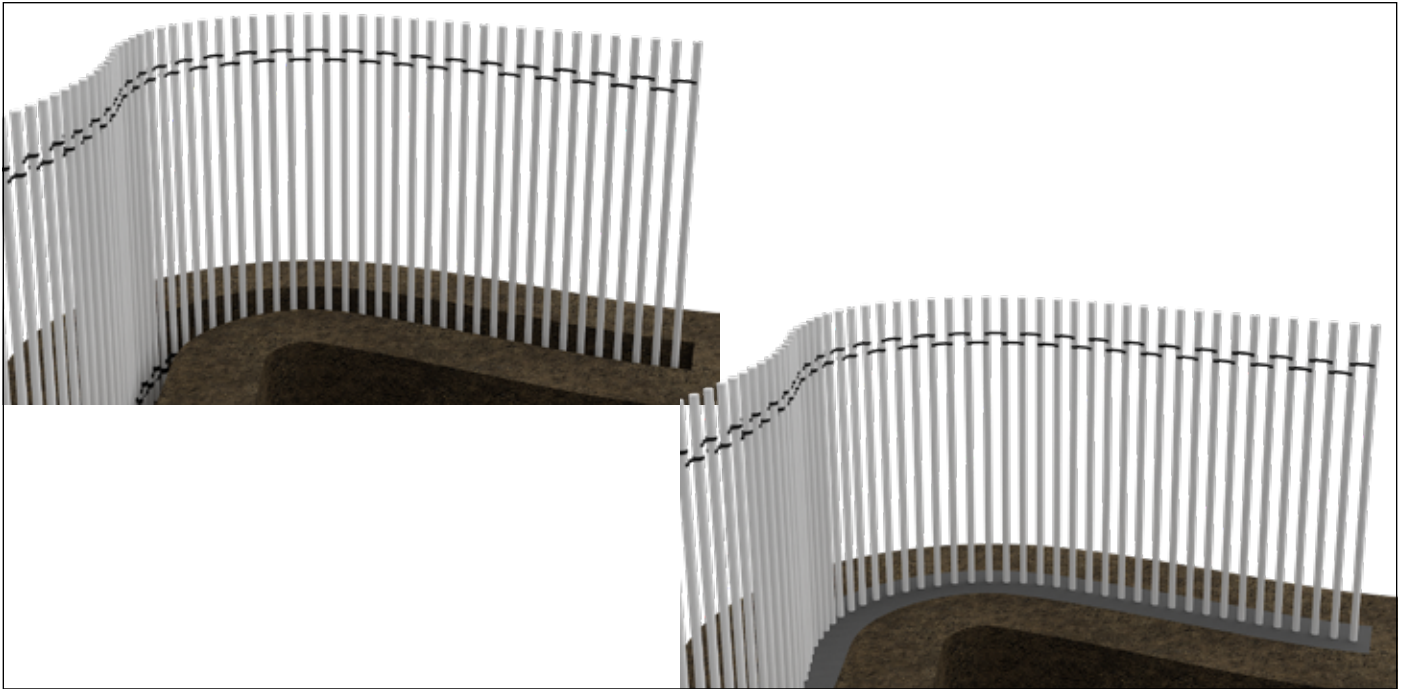

- iii Grout pickets into position ensuring each picket is vertical and in alignment as grout cures.
IMPORTANT: Ensure pickets are at a suitable height from ground level or step points so as to comply with required regulations.



- iv Once grout has fully cured, remove top clips.

INSTALLATION OVERVIEW

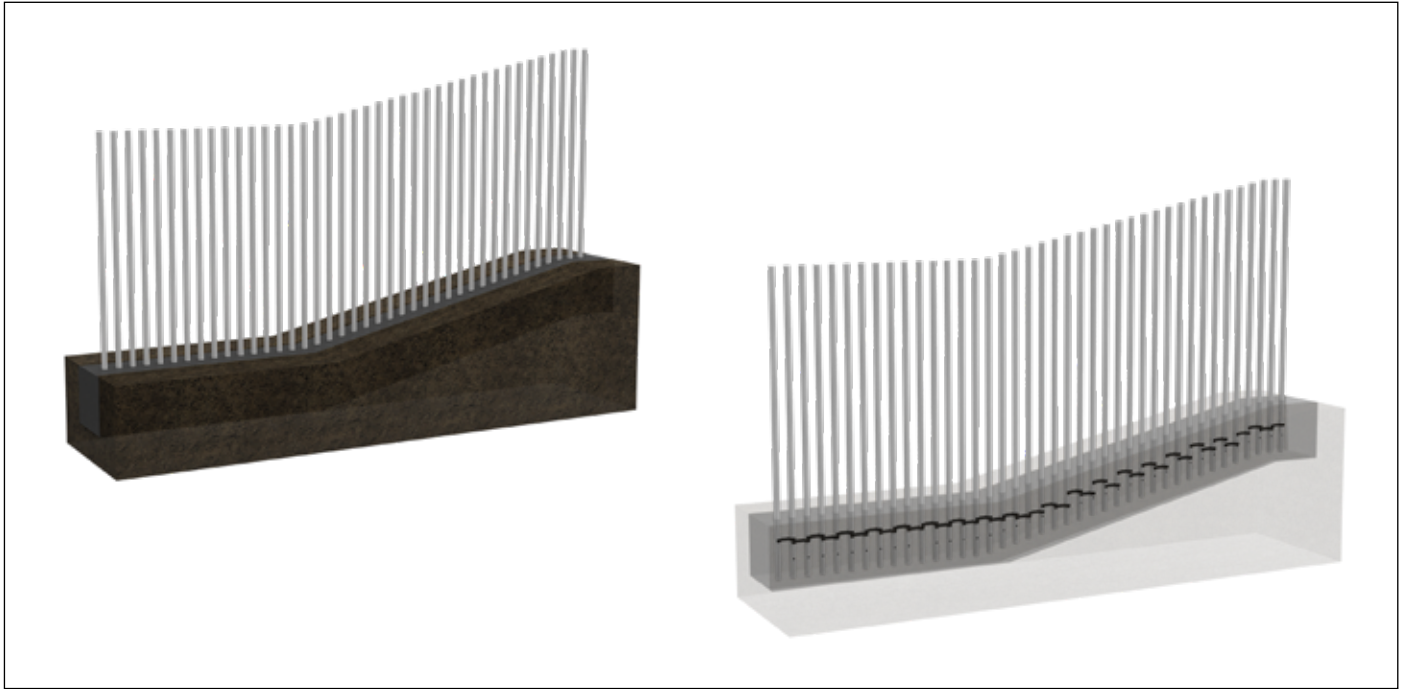

TRADE TIP: Kit in a Box pickets are ideal for raked installations – simply dig/create channel at the angle required and clip pickets into raked position. Clips will hold pickets at set heights while grout cures.

OPTION 2B – KIT IN A BOX – CORE DRILLED

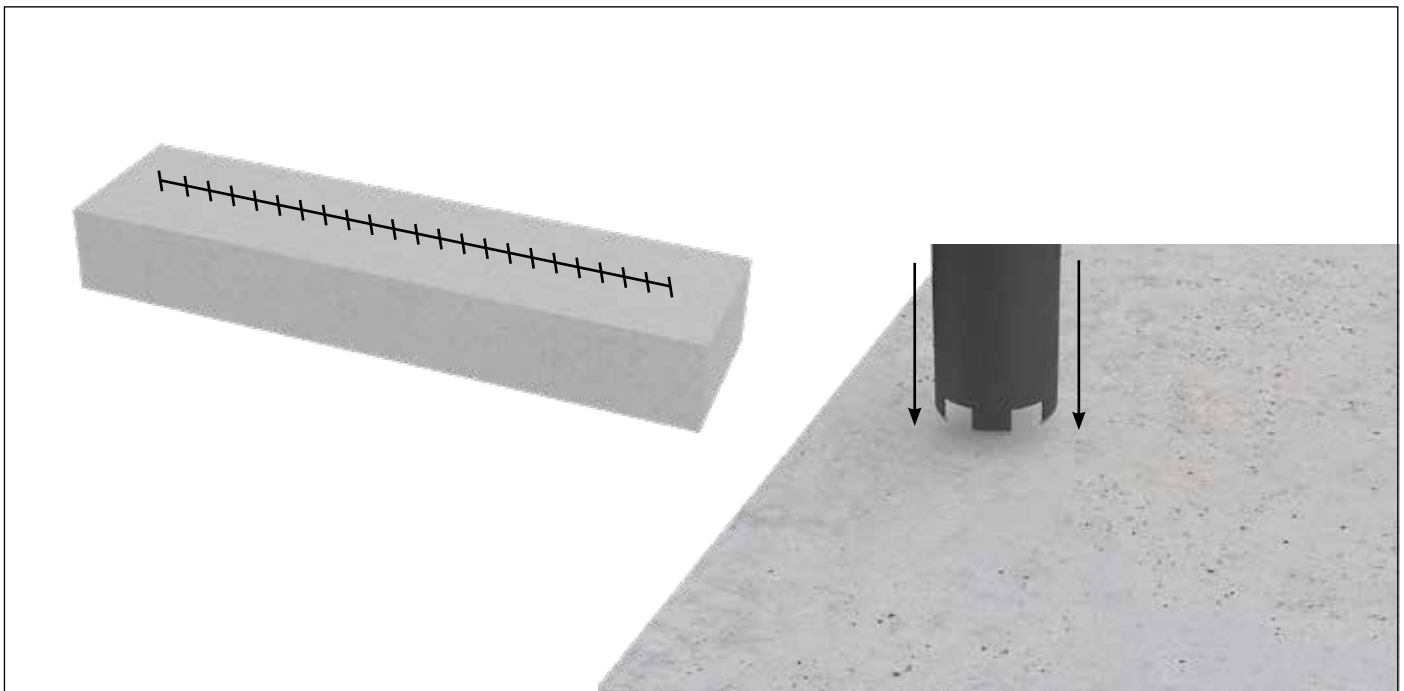

a Mark out, measure and core drill 42mm diameter holes at 80mm centre to centre spacings, approximately 100mm deep.
IMPORTANT: Consider earthing requirements

INSTALLATION OVERVIEW



b Insert trimmed PIK Pickets into the holes and join with top clips.

NOTE: Do not use bottom clips as they are difficult to remove.

IMPORTANT: For pool fence or gate applications, ensure the pickets sufficiently protrude from the finished ground line.

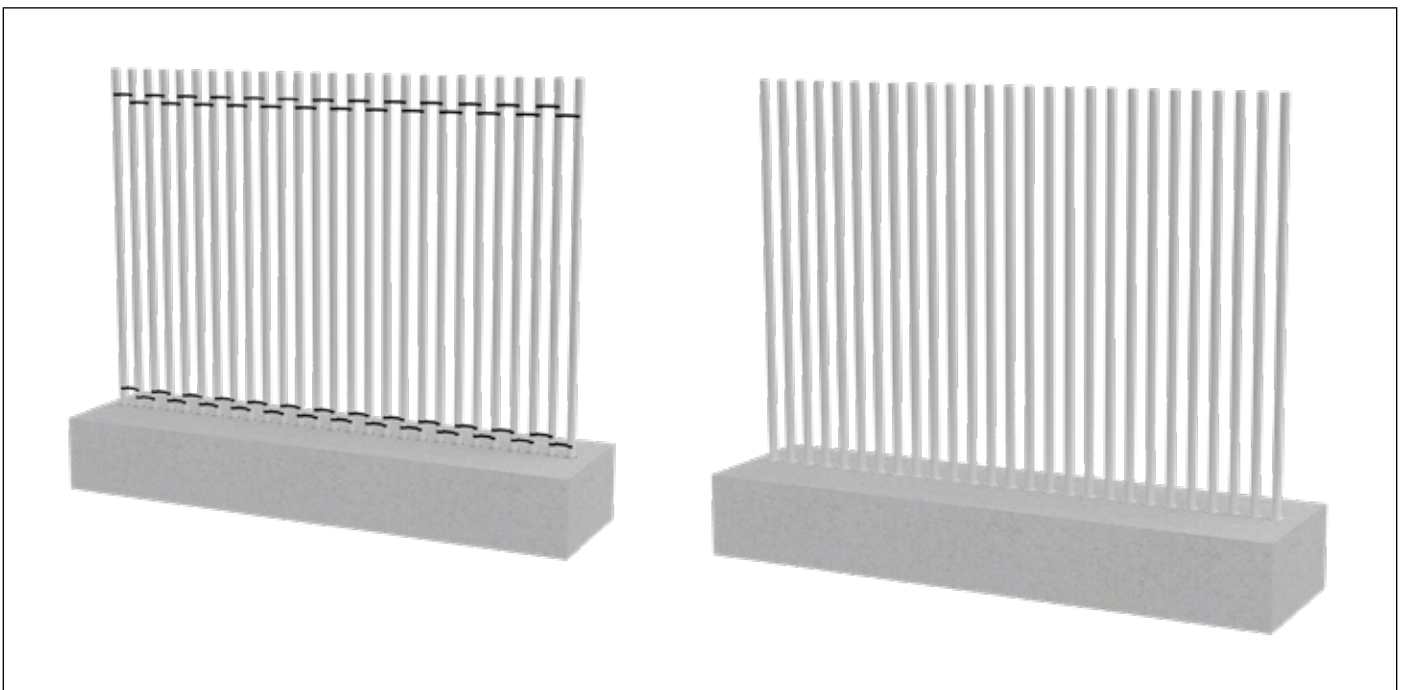

c Grout pickets into position.

Once grout is cured remove top clips from both bottom and top of pickets.

Install dress rings to finish.

INSTALLATION OVERVIEW

GATE INSTALLATION

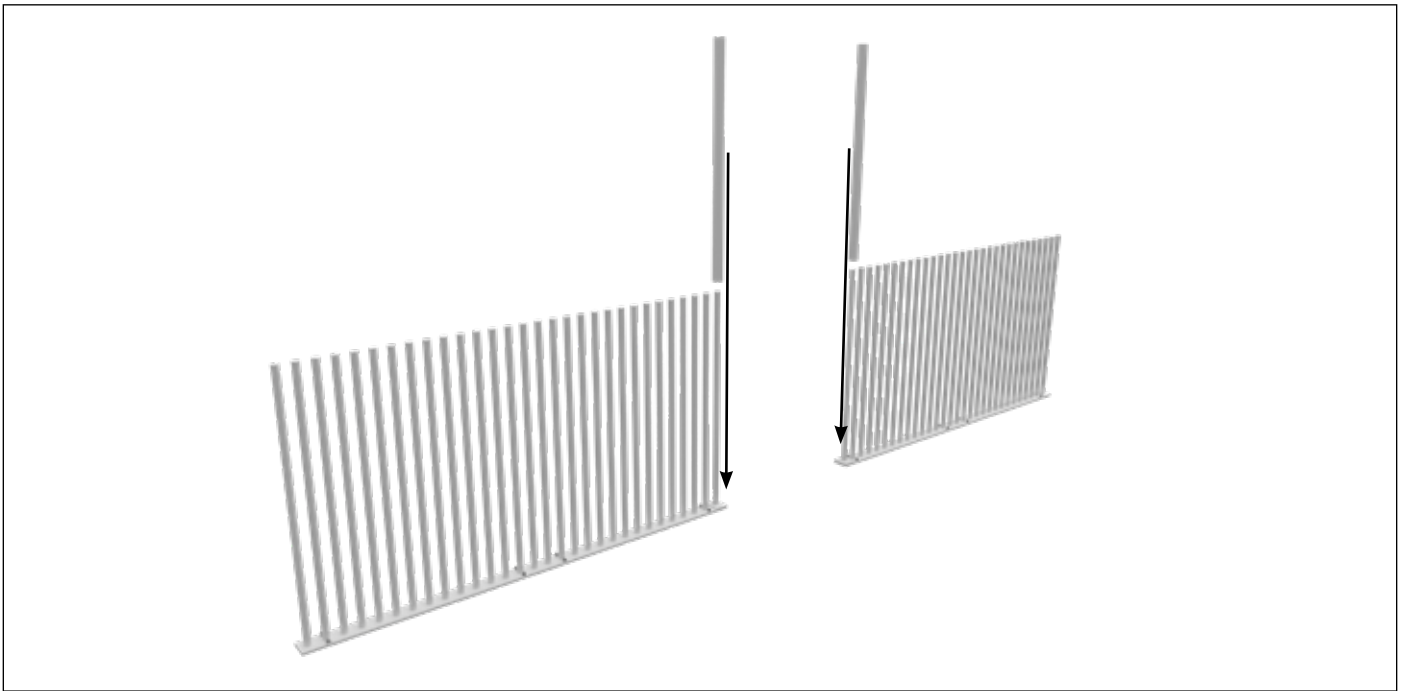

I Sleeve domical covers followed by 40x40mm square profiles onto first and last pickets.

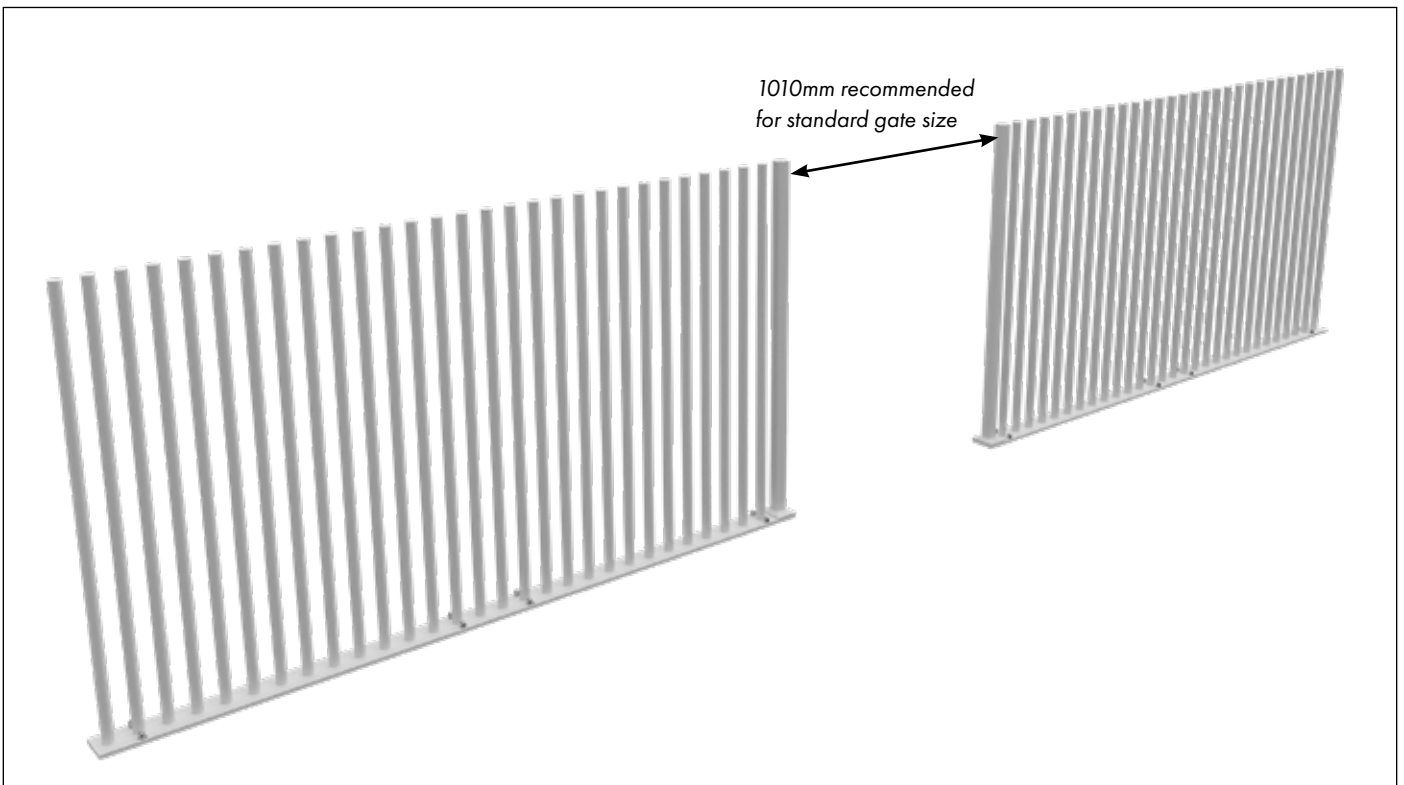

II An opening is now created with square posts for hinging and latching of gate.
Suggest to leave a 'daylight' opening width of 1010mm (21mm hinge gap + 975mm wide gate + 14mm latch gap).

INSTALLATION OVERVIEW

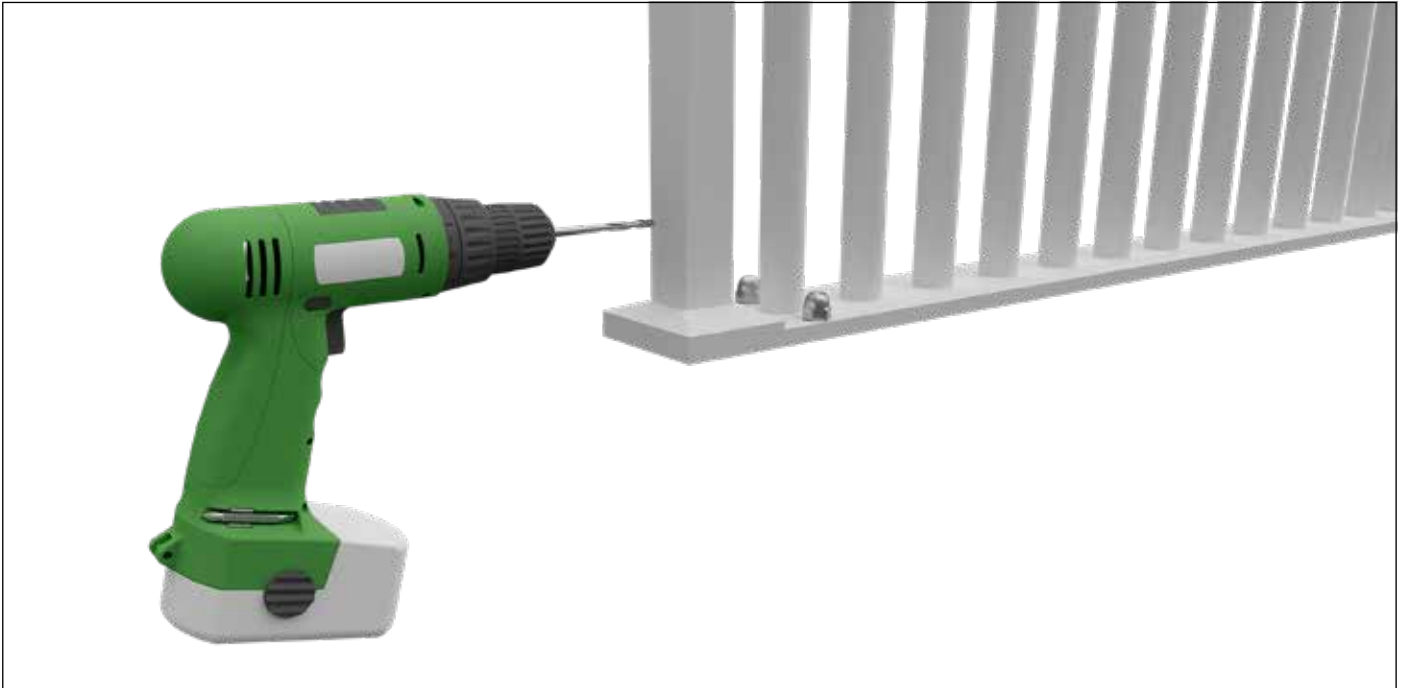

III Use drill bit provided. Drill through 40x40mm profile and 3mm wall of steel picket. Repeat for hinge and latch posts.

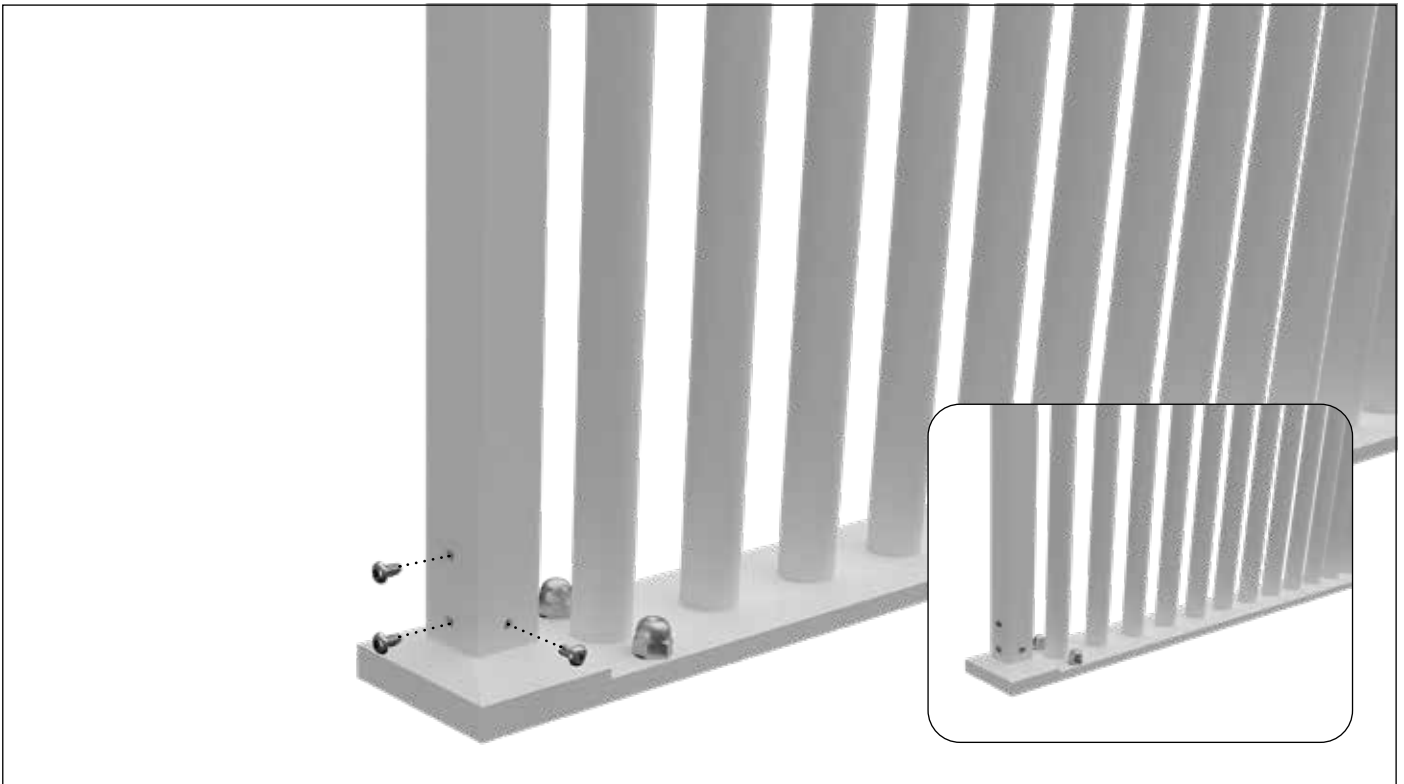

IV Drill 1 x hole on outer face of post and 2 x holes on inner face at bottom of post. Use self tapping screws provided and fix off screws. Repeat for hinge and latch posts.

INSTALLATION OVERVIEW

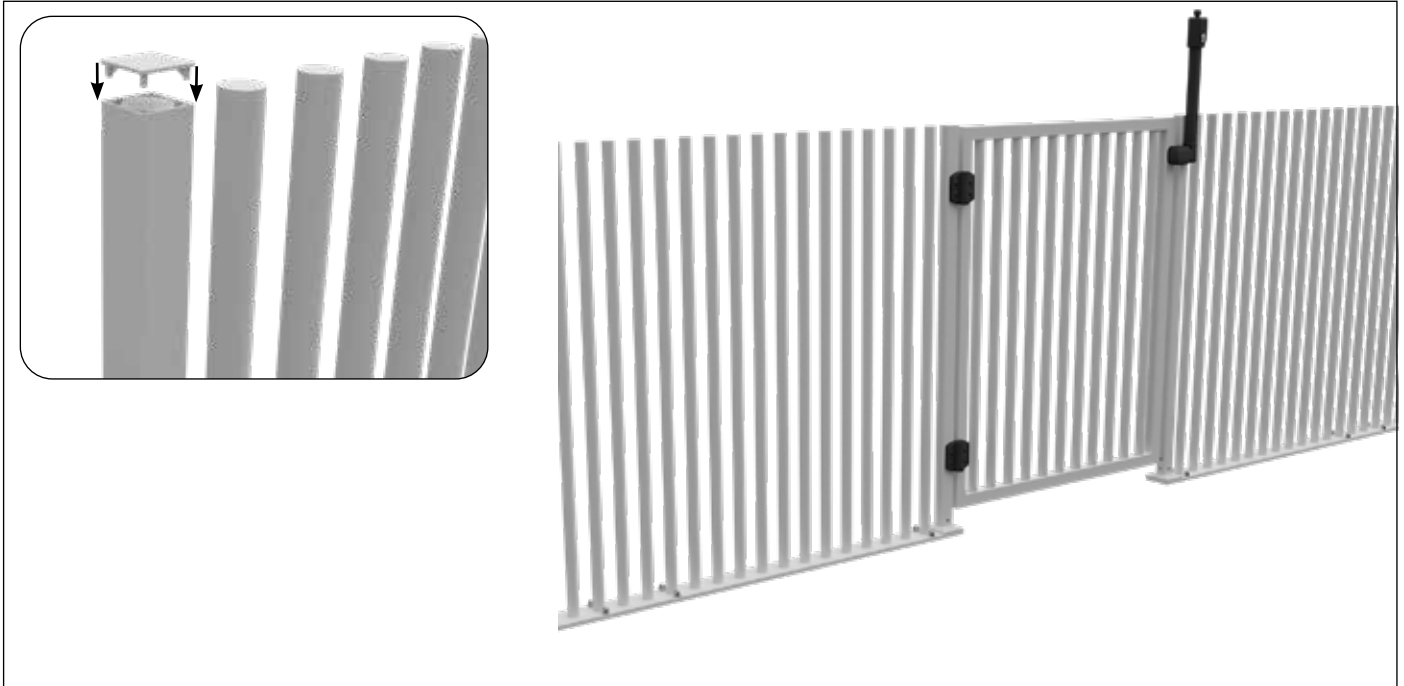

● Fit top cap.

Install gate with hinges and top pull latch.

If hinges/latch used for pool fencing application, ensure installation is in compliance with applicable regulations.

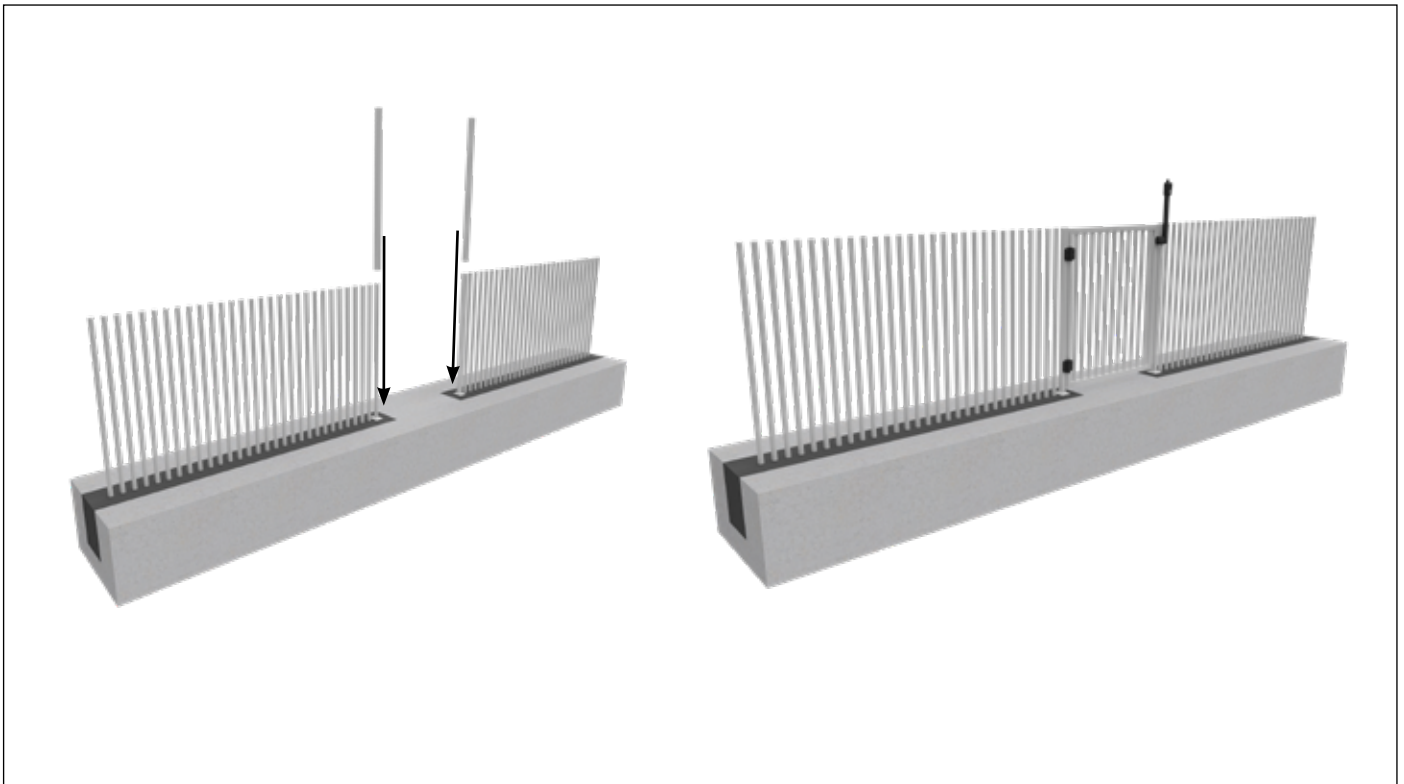

● **TRADE TIP:** The same installation methodology applies when pickets are grouted in. The 40x40mm profiles will require cutting to required height (use appropriate cutting blade to cut aluminium profiles).

LOGISTICS

LOGISTICS OPTION FOR WELDED PLINTH PIK® PANELS

Consideration must be had to logistics and handling due to weight of welded plinth PIK panels®. PIK® panels are packed in steel stillages that are ideal for forklift loading/unloading. There are 10 welded plinth panels per stillage. For ordering purposes, any quantity of PIK® welded plinth panels may be ordered with supply in stillage lots of 10 optimised plus individual panels as needed.



PICK UP FROM DEPOTS

It is recommended that a flat tray utility or flatbed truck be used with forklift unload at the receiving end.



DELIVERY VIA FLATBED TRUCK

Forklift unload at the receiving end is required. Due to weight consideration, hand unload is not available.



DELIVERY VIA CRANE TRUCK

GO has capability to deliver via crane truck from each depot with crane truck unload available to site.



DELIVERY VIA GENERAL FREIGHT COMPANY

GO is able to pack suitable for general freight sending nationwide – forklift loading and unloading required.



Steel stillage containing 10x PIK® panels with plinth

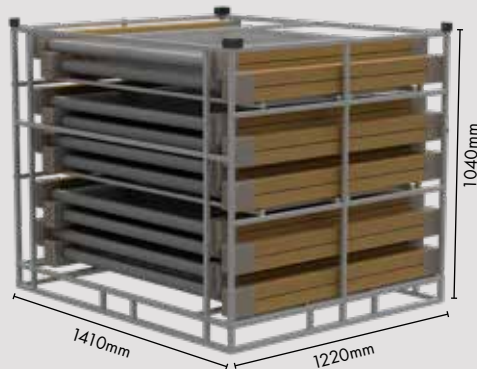

Weight: 570kg approx

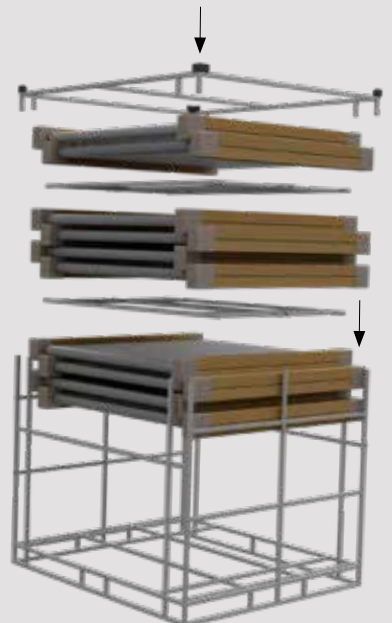



Errors and omissions excepted. Measurements and drawings are provided as a guide only and should not be relied upon solely for installation purposes.

Product codes, products and prices may change at GO's discretion as systems are constantly reviewed and updated. Please contact GO if you require clarification of product codes, pricing or product stocking.

Due to each installation situation being different, it is the installer's responsibility to seek engineering compliance and/or certification should it be required as part of a project, regulatory or statutory requirement.

As each installation site is different, it is the installer's responsibility to consider the impact of wind loads on the design of a fence. Please consult your engineer for site specific matters relating to wind loads.

Colours displayed in PDF's or printed documents are indicative only and should not be relied on as a true representation of actual powder coat colour. All products should adhere to a suitable care and maintenance schedule.

©Copyright 2024. This catalogue is the copyright of GO and cannot be reproduced, copied or replicated without the prior written consent of GO. Such consent applies to images as well as text.