

# MAXI-PURLIN

C&Z Purlins

 **STRATCO**



**Introduction**

Introduction	2
--------------	---

**Design and Specification Data**

Material	3
Lapping	3
Bolt Sizes	3
Maxi-Purlin Z and C Section Dimensions	3
Maxi-Purlin Z and C Section Properties	4
Section Capacities	4

**About The Tables**

How To Use Stratco Purlin & Girt Tables	5
Assumptions	5
Deflections	5

**Design Capacity Tables**

Single Spans	6
Two Continuous Spans	11
Two Lapped Spans	16
Three Lapped Spans	21
Four Lapped Spans	26
Cantilever Spans	31

**INTRODUCTION**

This booklet is supplementary to the current 'Stratco Purlins & Girts Capacity Tables and Technical Information Span Table Book.' Standard Z and C section dimensions have been modified slightly to achieve increased design capacities and create the Stratco Maxi-Purlin System.

These capacity tables have been calculated in accordance with limit state design principles and comply with Australian/New Zealand standard AS/NZS 4600: 2005 Cold-Formed Steel Structures.

Tables have been generated using the latest version of the purlin software developed by the Centre for Advanced Structural Engineering at the University of Sydney.

The Stratco Maxi-Purlin Z & C sections range from 150mm through to 350mm in depth and design capacity tables have been generated for a comprehensive range of span configurations.

The Stratco Rapidfix bridging system is suitable for use with the Maxi-Purlin range with further details available from the 'Stratco Purlins & Girts Capacity Tables and Technical Information Span Table Book'.

If any further details are required on the Stratco Maxi-Purlin System and its capabilities please contact Stratco for advice.

# DESIGN AND SPECIFICATION DATA

## MATERIAL

Stratco purlins are manufactured from hi-tensile, zinc coated steel tested for compliance with AS1397 and have a minimum yield stress of 450MPa. Refer to the Maxi-Purlin Z & C Section Dimensions Table for individual mass and steel grades for each section.

## LAPPING

Stratco Maxi-Purlin Z Sections require a lap length of 15% of the span and must be bolted in the outer web hole closest to the sheeting and the inner flange hole at both ends of the lap as shown in Figure 1.

The lap length is the distance between the bolt hole centres at the end of the laps.

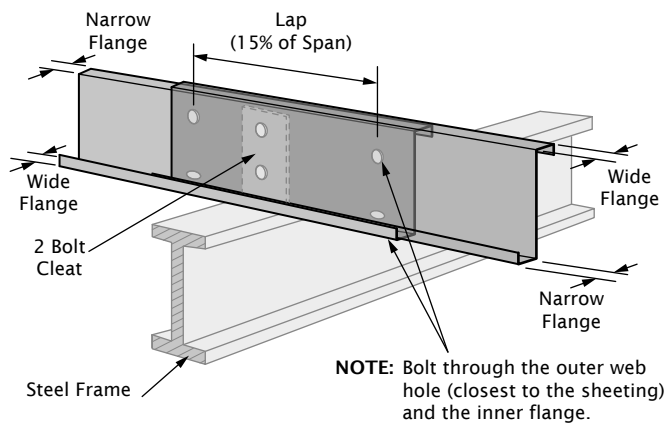

Figure 1

## BOLT SIZES

Bolting of section sizes from 150 to 250mm inclusive, at cleats and lapped joints, requires M12 grade 4.6 bolts to be used, 300 and 350mm sections require M16 grade 4.6 bolts.

If the shear capacity of the bolts is exceeded grade 8.8 bolts will be required and this is indicated by shading in the tables.

## MAXI-PURLIN Z & C SECTION DIMENSIONS

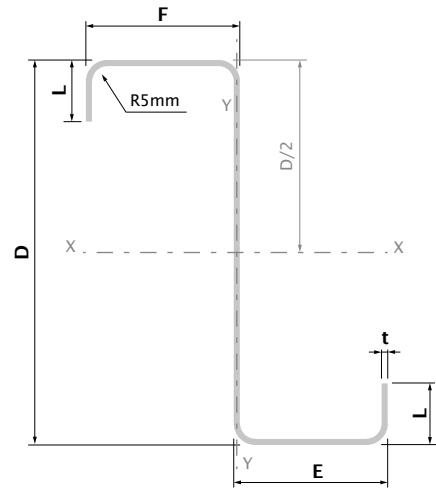

Stratco Maxi Z-Section

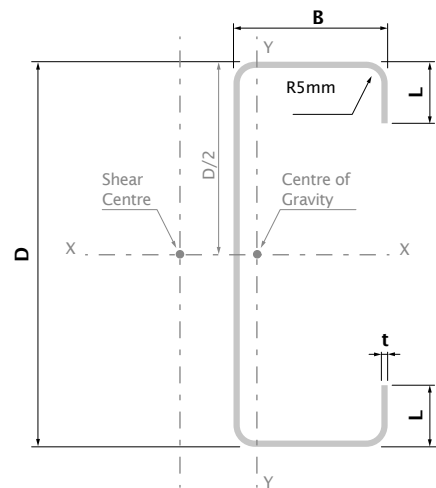

Stratco Maxi C-Section

## STRATCO MAXI-PURLIN Z-SECTION & C-SECTION

Section Size	Material Properties (MPa)			Dimensions						Mass kg/m
	Yield Stress $f_y$	Ult. Tensile Strength $f_u$	t mm	D mm	Z-Section			C-Section		
					E mm	F mm	L mm	B mm	L mm	
150-10	550	550	1.0	150	61	57	20	58	21.0	2.40
150-12	500	520	1.2	150	61	57	21	58	21.5	2.86
150-15	450	480	1.5	150	61	57	21.5	58	22.5	3.58
150-19	450	480	1.9	150	61	57	22.5	58	23.5	4.50
150-24	450	480	2.4	150	61	57	23.5	58	24.5	5.66
200-12	500	520	1.2	200	74	69	21	72	20.0	3.59
200-15	450	480	1.5	200	74	69	22	72	21.0	4.49
200-19	450	480	1.9	200	74	69	25	72	24.5	5.72
200-24	450	480	2.4	200	74	69	26	72	25.5	7.20
250-15	450	480	1.5	250	76	71	22	73	22.5	5.15
250-19	450	480	1.9	250	76	71	23	73	23.5	6.49
250-24	450	480	2.4	250	76	71	24	73	24.5	8.16
300-19	450	480	1.9	300	98	91	27	93	28.5	8.01
300-24	450	480	2.4	300	98	91	28	93	29.5	10.07
300-30	450	480	3.0	300	98	91	32	93	33.5	12.67
350-19	450	480	1.9	350	124	116	31.5	120	31.5	9.69
350-24	450	480	2.4	350	124	116	33	120	32.5	12.19
350-30	450	480	3.0	350	124	116	34	120	34.0	15.18

## MAXI-PURLIN Z & C SECTION PROPERTIES

### MAXI Z-SECTION

Section Size	Full Z Section Properties							Effective Properties	
	$A_g$ mm <sup>2</sup>	$I_x$ x10 <sup>6</sup> mm <sup>4</sup>	$Z_x$ x10 <sup>3</sup> mm <sup>3</sup>	$I_y$ x10 <sup>6</sup> mm <sup>4</sup>	$Z_y$ x10 <sup>3</sup> mm <sup>3</sup>	J mm <sup>4</sup>	$I_w$ x10 <sup>9</sup> mm <sup>6</sup>	$Z_{ex}^\dagger$ x10 <sup>3</sup> mm <sup>3</sup>	$A_e^\ddagger$ mm <sup>2</sup>
MXZ150-10	295	1.029	13.63	0.245	4.15	98	0.951	9.8	142
MXZ150-12	354	1.233	16.36	0.298	5.07	170	1.162	13.46	193
MXZ150-15	443	1.53	20.33	0.37	6.34	332	1.443	18.11	272
MXZ150-19	561	1.923	25.62	0.47	8.09	674	1.832	24.3	399
MXZ150-24	708	2.4	32.08	0.59	10.25	1357	2.3	32.01	577
MXZ200-12	444	2.724	27.04	0.491	6.85	213	3.401	18.19	195
MXZ200-15	555	3.396	33.76	0.618	8.67	417	4.289	26.8	283
MXZ200-19	713	4.322	43.06	0.821	11.59	857	5.749	38.2	416
MXZ200-24	900	5.413	54.07	1.033	14.68	1726	7.229	51.06	608
MXZ250-15	638	5.839	46.45	0.664	9.05	478	7.477	33.45	285
MXZ250-19	808	7.366	58.69	0.843	11.55	972	9.491	48.39	405
MXZ250-24	1020	9.244	73.8	1.062	14.64	1956	11.94	67.57	588
MXZ300-19	998	13.4	88.7	1.771	18.73	1200	28.19	63.51	448
MXZ300-24	1260	16.83	111.6	2.231	23.73	2417	35.51	91.72	635
MXZ300-30	1590	21.15	140.6	2.922	31.28	4766	46.78	127	924
MXZ350-19	1207	22.6	128.2	3.57	29.68	1452	75.91	81.12	492
MXZ350-24	1524	28.46	161.7	4.535	37.87	2928	96.48	116.5	700
MXZ350-30	1905	35.36	201.3	5.642	47.35	5711	119.9	166.1	977

†  $Z_{ex}$  is the effective modulus at yield (bending)

‡  $A_e$  is the effective area at yield (compression)

### MAXI C-SECTION

Section Size	Full C Section Properties							Effective Properties	
	$A_g$ mm <sup>2</sup>	$I_x$ x10 <sup>6</sup> mm <sup>4</sup>	$Z_x$ x10 <sup>3</sup> mm <sup>3</sup>	$I_y$ x10 <sup>6</sup> mm <sup>4</sup>	$Z_y$ x10 <sup>3</sup> mm <sup>3</sup>	J mm <sup>4</sup>	$I_w$ x10 <sup>9</sup> mm <sup>6</sup>	$Z_{ex}^\dagger$ x10 <sup>3</sup> mm <sup>3</sup>	$A_e^\ddagger$ mm <sup>2</sup>
MXC150-10	295	1.024	13.75	0.145	3.71	98	0.722	9.72	141
MXC150-12	354	1.224	16.45	0.173	4.48	170	0.871	13.63	196
MXC150-15	443	1.523	20.51	0.217	5.67	332	1.107	18.37	278
MXC150-19	561	1.913	25.83	0.274	7.24	674	1.415	24.88	416
MXC150-24	708	2.387	32.34	0.343	9.19	1357	1.788	31.83	577
MXC200-12	444	2.722	27.38	0.308	6.08	213	2.471	17.74	190
MXC200-15	555	3.393	34.19	0.387	7.7	416	3.129	26.25	277
MXC200-19	713	4.331	43.73	0.514	10.45	857	4.325	37.97	413
MXC200-24	900	5.425	54.91	0.645	13.25	1726	5.461	50.63	601
MXC250-15	638	5.833	46.95	0.441	8.32	478	5.478	33.8	288
MXC250-19	808	7.358	59.32	0.558	10.63	972	6.969	48.76	409
MXC250-24	1020	9.233	74.58	0.701	13.48	1956	8.785	67.99	593
MXC300-19	998	13.36	89.64	1.145	17.19	1200	20.65	65.19	461
MXC300-24	1260	16.78	112.8	1.44	21.78	2417	26.05	93.58	648
MXC300-30	1590	21.08	141.9	1.862	28.74	4766	34.64	129.1	948
MXC350-19	1207	22.6	129.9	2.302	26.84	1452	55.59	81.12	492
MXC350-24	1524	28.42	163.5	2.898	34.01	2924	70.19	115.6	695
MXC350-30	1905	35.37	203.9	3.623	42.87	5711	88.19	166.1	977

†  $Z_{ex}$  is the effective modulus at yield (bending)

‡  $A_e$  is the effective area at yield (compression)

## SECTION CAPACITIES

Section Size	AZ Section		AC Section	
	$\phi_b M_s$ kNm	$\phi_v V_v$ kN	$\phi_b M_s$ kNm	$\phi_v V_v$ kN
150-10	5.1	6.3	5.1	6.3
150-12	6.4	10.9	6.5	10.9
150-15	7.7	21.4	7.9	21.4
150-19	10.4	43.8	10.6	43.8
150-24	13.7	72.7	13.6	72.7
200-12	8.6	8	8.4	8
200-15	11.5	15.7	11.2	15.7
200-19	16.3	32	16.2	32
200-24	21.8	64.9	21.6	64.9
250-15	14.3	12.4	14.4	12.4
250-19	20.7	25.3	20.8	25.3
250-24	28.9	51.1	29.1	51.1
300-19	27.2	20.8	27.9	20.8
300-24	39.2	42.2	40	42.2
300-30	54.3	82.7	55.2	82.7
350-19	34.7	17.7	34.7	17.7
350-24	49.8	35.9	49.4	35.9
350-30	71	70.3	71	70.3

# ABOUT THE TABLES

## HOW TO USE STRATCO PURLIN AND GIRT TABLES

The design capacity tables indicate the maximum allowable limit state design uniformly distributed loads that can be applied to the sections. As the tables assume uniformly distributed loads, any point loading must be converted to uniformly distributed loads to enable the tables to be correctly used. Once the outward and inward loads on the members have been determined in accordance with the relevant standards, the appropriate table may be used to determine the best section sizes and bridging requirements. Linear interpolation is permitted for intermediate span values.

## ASSUMPTIONS

The Design Capacity Tables assume that sections are bent about the axis perpendicular to the web and there is continuity at any laps. It is also assumed sections are provided with lateral stability in the plane of the roof at internal supports and at the ends of cantilevers. In addition, these tables are based on the assumption that roofing and walling provide lateral restraint to the purlin flange to which it is attached and that there is restraint against twisting and lateral movement at the bridging points.

Where a section is not loaded to its full capacity the reserve capacity will allow it to resist forces other than bending, e.g. axial loading due to bracing of roof or wall structures. Sections subject to forces other than those inducing bending about the major axis must be designed in accordance with AS/NZS 4600.

It is important to ensure any construction loading is accounted for and care is taken during installation to avoid buckling or distorting the shape of sections as this can adversely affect performance. The tables do not take into account the ability of the roof or wall cladding to carry the published loads. Refer to relevant Stratco documentation on roofing and walling to determine cladding requirements.

## DEFLECTIONS

The values shown in the 'Def'n L/150' column are the uniformly distributed loads required to produce a maximum deflection of span/150. The deflection limit is applicable to both inward and outward load cases and loads for other deflection ratios may be obtained by simple proportion.



# 1 SINGLE



## DESIGN CAPACITY TABLES

Single spans are simply supported at each end of the purlin.

(Tables in kN/m)

C/Z150-10									
Span	Inward				Outward				Def 'n L/150
	0	1	2	3	0	1	2	3	
2000	6.30	6.30	6.30	6.30	6.30	6.30	6.30	6.30	11.90
2500	5.04	5.04	5.04	5.04	5.04	5.04	5.04	5.04	6.09
3000	3.78	3.78	3.78	3.78	3.06	3.78	3.78	3.78	3.53
3500	2.78	2.78	2.78	2.78	1.80	2.78	2.78	2.78	2.22
4000	2.13	2.13	2.13	2.13	1.11	2.11	2.13	2.13	1.49
4500	1.68	1.68	1.68	1.68	0.72	1.56	1.68	1.68	1.05
5000	1.36	1.36	1.36	1.36	0.49	1.17	1.36	1.36	0.76
5500	1.12	1.12	1.12	1.12	0.34	0.88	1.12	1.12	0.57
6000	0.95	0.95	0.95	0.95	0.25	0.64	0.92	0.95	0.44
6500	0.81	0.81	0.81	0.81	0.18	0.48	0.75	0.81	0.35
7000	0.69	0.69	0.69	0.69	0.14	0.37	0.61	0.69	0.28
7500	0.60	0.61	0.61	0.61	0.11	0.28	0.50	0.60	0.23
8000	0.53	0.53	0.53	0.53	0.08	0.22	0.41	0.51	0.19
8500	0.47	0.47	0.47	0.47	0.07	0.18	0.33	0.44	0.16

C/Z150-12									
Span	Inward				Outward				Def 'n L/150
	0	1	2	3	0	1	2	3	
2000	10.51	10.51	10.51	10.51	10.51	10.51	10.51	10.51	14.85
2500	6.73	6.73	6.73	6.73	6.57	6.72	6.72	6.72	7.60
3000	4.67	4.67	4.67	4.67	3.88	4.67	4.67	4.67	4.40
3500	3.43	3.43	3.43	3.43	2.27	3.43	3.43	3.43	2.77
4000	2.63	2.63	2.63	2.63	1.40	2.63	2.63	2.63	1.86
4500	2.08	2.08	2.08	2.08	0.91	2.02	2.08	2.08	1.30
5000	1.68	1.68	1.68	1.68	0.61	1.50	1.68	1.68	0.95
5500	1.39	1.39	1.39	1.39	0.42	1.11	1.39	1.39	0.71
6000	1.17	1.17	1.17	1.17	0.31	0.82	1.17	1.17	0.55
6500	1.00	1.00	1.00	1.00	0.23	0.61	0.96	1.00	0.43
7000	0.86	0.86	0.86	0.86	0.17	0.46	0.78	0.86	0.35
7500	0.75	0.75	0.75	0.75	0.13	0.36	0.64	0.75	0.28
8000	0.66	0.66	0.66	0.66	0.11	0.28	0.52	0.66	0.23
8500	0.58	0.58	0.58	0.58	0.09	0.22	0.42	0.56	0.19

C/Z150-15									
Span	Inward				Outward				Def 'n L/150
	0	1	2	3	0	1	2	3	
2000	13.42	13.42	13.42	13.42	13.42	13.42	13.42	13.42	18.90
2500	8.56	8.59	8.59	8.59	7.96	8.59	8.59	8.59	9.68
3000	5.82	5.96	5.96	5.96	4.94	5.96	5.96	5.96	5.60
3500	4.20	4.38	4.38	4.38	3.02	4.38	4.38	4.38	3.53
4000	3.17	3.35	3.35	3.36	1.82	3.30	3.35	3.36	2.36
4500	2.48	2.65	2.65	2.65	1.17	2.46	2.65	2.65	1.66
5000	1.99	2.15	2.15	2.15	0.79	1.86	2.15	2.15	1.21
5500	1.63	1.77	1.77	1.77	0.55	1.44	1.77	1.77	0.91
6000	1.36	1.49	1.49	1.49	0.40	1.09	1.44	1.49	0.70
6500	1.15	1.27	1.27	1.27	0.30	0.81	1.17	1.27	0.55
7000	0.98	1.10	1.10	1.10	0.23	0.61	0.96	1.10	0.44
7500	0.85	0.95	0.95	0.95	0.18	0.47	0.80	0.94	0.36
8000	0.75	0.84	0.84	0.84	0.15	0.36	0.67	0.80	0.30
8500	0.66	0.74	0.74	0.74	0.12	0.29	0.55	0.68	0.25
9000	0.58	0.66	0.66	0.66	0.10	0.23	0.45	0.59	0.21

C/Z150-19									
Span	Inward				Outward				Def 'n L/150
	0	1	2	3	0	1	2	3	
2000	18.43	18.61	18.61	18.61	18.61	18.61	18.61	18.61	24.23
2500	11.43	11.91	11.91	11.91	10.86	11.91	11.91	11.91	12.41
3000	7.67	8.27	8.27	8.27	6.49	8.27	8.27	8.27	7.18
3500	5.49	6.08	6.08	6.08	3.91	6.08	6.08	6.08	4.52
4000	4.11	4.65	4.65	4.65	2.38	4.55	4.65	4.65	3.03
4500	3.19	3.68	3.68	3.68	1.54	3.36	3.68	3.68	2.13
5000	2.54	2.98	2.98	2.98	1.05	2.51	2.98	2.98	1.55
5500	2.07	2.46	2.46	2.46	0.75	1.89	2.44	2.46	1.17
6000	1.72	2.07	2.07	2.07	0.55	1.42	1.98	2.07	0.90
6500	1.45	1.76	1.76	1.76	0.42	1.06	1.60	1.76	0.71
7000	1.24	1.52	1.52	1.52	0.32	0.80	1.31	1.51	0.57
7500	1.07	1.32	1.32	1.32	0.26	0.61	1.07	1.29	0.46
8000	0.93	1.16	1.16	1.16	0.21	0.48	0.88	1.10	0.38
8500	0.82	1.03	1.03	1.03	0.17	0.38	0.72	0.94	0.32
9000	0.72	0.92	0.92	0.92	0.14	0.31	0.58	0.80	0.27

C/Z150-24									
Span	Inward				Outward				Def 'n L/150
	0	1	2	3	0	1	2	3	
2000	22.74	25.28	25.28	25.28	23.78	25.28	25.28	25.28	30.26
2500	13.79	16.18	16.18	16.18	13.64	16.18	16.18	16.18	15.64
3000	9.18	11.24	11.24	11.24	8.23	11.24	11.24	11.24	9.05
3500	6.51	8.26	8.26	8.26	5.04	7.89	8.26	8.26	5.70
4000	4.85	6.26	6.32	6.32	3.12	5.72	6.32	6.32	3.82
4500	3.74	4.87	4.99	4.99	2.05	4.24	4.94	5.00	2.68
5000	2.97	3.89	4.05	4.05	1.42	3.19	3.87	4.05	1.96
5500	2.41	3.17	3.34	3.34	1.02	2.41	3.09	3.34	1.47
6000	2.00	2.64	2.80	2.81	0.76	1.83	2.49	2.76	1.13
6500	1.68	2.23	2.36	2.39	0.58	1.39	2.02	2.30	0.89
7000	1.43	1.90	2.02	2.06	0.46	1.05	1.66	1.92	0.71
7500	1.23	1.64	1.74	1.80	0.37	0.82	1.36	1.63	0.58
8000	1.07	1.44	1.52	1.58	0.30	0.64	1.12	1.38	0.48
8500	0.94	1.26	1.33	1.38	0.25	0.52	0.92	1.18	0.40
9000	0.83	1.12	1.18	1.23	0.21	0.42	0.76	1.01	0.34

**NOTE:** Bolting of section sizes from 100 to 250mm inclusive requires M12 grade 4.6 bolts. 300mm and 350mm sections require M16 grade 4.6 bolts. Shaded values require grade 8.8 bolts.

# DESIGN CAPACITY TABLES

Single spans are simply supported at each end of the purlin.

(Tables in kN/m)



# 1 SINGLE

C/Z200-12									
Span	Inward				Outward				Def 'n L/150
	0	1	2	3	0	1	2	3	
2000	8.01	8.01	8.01	8.01	8.01	8.01	8.01	8.01	26.96
2500	6.41	6.41	6.41	6.41	6.41	6.41	6.41	6.41	15.81
3000	5.34	5.34	5.34	5.34	5.34	5.34	5.34	5.34	9.15
3500	4.58	4.58	4.58	4.58	4.03	4.58	4.58	4.58	5.76
4000	3.56	3.64	3.64	3.64	2.70	3.64	3.64	3.64	3.86
4500	2.78	2.88	2.88	2.88	1.81	2.88	2.88	2.88	2.71
5000	2.23	2.33	2.33	2.33	1.24	2.25	2.33	2.33	1.98
5500	1.83	1.93	1.93	1.93	0.88	1.78	1.93	1.93	1.48
6000	1.53	1.62	1.62	1.62	0.64	1.41	1.62	1.62	1.14
6500	1.29	1.38	1.38	1.38	0.47	1.12	1.38	1.38	0.90
7000	1.11	1.19	1.19	1.19	0.36	0.90	1.16	1.19	0.72
7500	0.96	1.04	1.04	1.04	0.27	0.72	0.98	1.04	0.59
8000	0.84	0.91	0.91	0.91	0.21	0.57	0.83	0.91	0.48
8500	0.74	0.81	0.81	0.81	0.17	0.46	0.71	0.81	0.40
9000	0.66	0.72	0.72	0.72	0.14	0.37	0.61	0.71	0.34
9500	0.59	0.65	0.65	0.65	0.11	0.30	0.52	0.62	0.29
10000	0.53	0.58	0.58	0.58	0.09	0.25	0.44	0.55	0.25

C/Z200-15									
Span	Inward				Outward				Def 'n L/150
	0	1	2	3	0	1	2	3	
2000	15.70	15.70	15.70	15.70	15.70	15.70	15.70	15.70	40.29
2500	12.21	12.21	12.21	12.21	12.21	12.21	12.21	12.21	20.63
3000	8.48	8.48	8.48	8.48	8.31	8.48	8.48	8.48	11.94
3500	6.22	6.23	6.23	6.23	5.45	6.23	6.23	6.23	7.52
4000	4.70	4.77	4.77	4.77	3.56	4.77	4.77	4.77	5.04
4500	3.67	3.77	3.77	3.77	2.35	3.77	3.77	3.77	3.54
5000	2.94	3.05	3.05	3.05	1.65	3.05	3.05	3.05	2.58
5500	2.40	2.52	2.52	2.52	1.15	2.45	2.52	2.52	1.94
6000	1.99	2.12	2.12	2.12	0.82	1.93	2.12	2.12	1.49
6500	1.68	1.81	1.81	1.81	0.61	1.52	1.81	1.81	1.17
7000	1.43	1.56	1.56	1.56	0.46	1.19	1.56	1.56	0.94
7500	1.24	1.36	1.36	1.36	0.35	0.93	1.35	1.36	0.76
8000	1.08	1.19	1.19	1.19	0.28	0.74	1.15	1.19	0.63
8500	0.95	1.06	1.06	1.06	0.22	0.61	0.97	1.06	0.53
9000	0.84	0.94	0.94	0.94	0.18	0.49	0.82	0.94	0.44
9500	0.75	0.85	0.85	0.85	0.15	0.40	0.70	0.85	0.38
10000	0.67	0.76	0.76	0.76	0.12	0.33	0.59	0.75	0.32

C/Z200-19									
Span	Inward				Outward				Def 'n L/150
	0	1	2	3	0	1	2	3	
2000	27.98	27.98	27.98	27.98	27.98	27.98	27.98	27.98	53.28
2500	17.33	17.91	17.91	17.91	17.91	17.91	17.91	17.91	27.28
3000	11.55	12.44	12.44	12.44	11.50	12.44	12.44	12.44	15.79
3500	8.20	9.14	9.14	9.14	7.67	9.14	9.14	9.14	9.94
4000	6.12	7.00	7.00	7.00	5.23	7.00	7.00	7.00	6.66
4500	4.74	5.53	5.53	5.53	3.35	5.53	5.53	5.53	4.68
5000	3.77	4.48	4.48	4.48	2.24	4.33	4.48	4.48	3.41
5500	3.07	3.70	3.70	3.70	1.57	3.39	3.70	3.70	2.56
6000	2.55	3.11	3.11	3.11	1.13	2.70	3.11	3.11	1.97
6500	2.14	2.65	2.65	2.65	0.84	2.17	2.65	2.65	1.55
7000	1.83	2.28	2.28	2.28	0.64	1.76	2.23	2.28	1.24
7500	1.58	1.99	1.99	1.99	0.50	1.37	1.88	1.99	1.01
8000	1.37	1.75	1.75	1.75	0.39	1.07	1.59	1.75	0.83
8500	1.21	1.55	1.55	1.55	0.32	0.84	1.35	1.55	0.69
9000	1.07	1.37	1.38	1.38	0.26	0.68	1.16	1.36	0.59
9500	0.95	1.23	1.24	1.24	0.21	0.55	1.00	1.19	0.50
10000	0.85	1.10	1.12	1.12	0.18	0.45	0.86	1.04	0.43
10500	0.77	0.99	1.02	1.02	0.15	0.37	0.73	0.92	0.37
11000	0.70	0.90	0.93	0.93	0.13	0.31	0.61	0.81	0.32
11500	0.63	0.82	0.85	0.85	0.11	0.26	0.51	0.72	0.28

C/Z200-24									
Span	Inward				Outward				Def 'n L/150
	0	1	2	3	0	1	2	3	
2000	38.00	38.76	38.76	38.76	38.76	38.76	38.76	38.76	68.04
2500	23.03	24.81	24.80	24.80	24.49	24.80	24.80	24.80	34.84
3000	15.20	17.23	17.23	17.23	15.74	17.23	17.23	17.23	20.16
3500	10.59	12.66	12.66	12.66	10.25	12.66	12.66	12.66	12.70
4000	7.74	9.69	9.69	9.69	6.65	9.69	9.69	9.69	8.51
4500	5.87	7.66	7.66	7.66	4.30	7.59	7.66	7.66	5.97
5000	4.59	6.20	6.20	6.20	2.90	5.92	6.20	6.20	4.35
5500	3.68	5.13	5.13	5.13	2.04	4.66	5.13	5.13	3.27
6000	3.01	4.28	4.31	4.31	1.48	3.67	4.31	4.31	2.52
6500	2.50	3.62	3.67	3.67	1.11	2.89	3.63	3.67	1.98
7000	2.11	3.09	3.16	3.16	0.85	2.27	3.05	3.16	1.59
7500	1.80	2.67	2.76	2.76	0.67	1.77	2.57	2.76	1.29
8000	1.55	2.33	2.42	2.42	0.53	1.38	2.18	2.42	1.06
8500	1.35	2.04	2.15	2.15	0.43	1.10	1.85	2.12	0.89
9000	1.19	1.81	1.91	1.91	0.36	0.88	1.56	1.86	0.75
9500	1.05	1.61	1.71	1.72	0.30	0.72	1.32	1.63	0.64
10000	0.94	1.44	1.53	1.55	0.25	0.59	1.11	1.43	0.54
10500	0.84	1.30	1.38	1.41	0.21	0.49	0.94	1.26	0.47
11000	0.76	1.18	1.25	1.28	0.18	0.42	0.79	1.11	0.41
11500	0.69	1.07	1.14	1.17	0.16	0.35	0.66	0.98	0.36

**NOTE:** Bolting of section sizes from 100 to 250mm inclusive requires M12 grade 4.6 bolts. 300mm and 350mm sections require M16 grade 4.6 bolts. Shaded values require grade 8.8 bolts.

# 1 SINGLE



## DESIGN CAPACITY TABLES

Single spans are simply supported at each end of the purlin.

(Tables in kN/m)

C/Z250-15									
Span	Inward				Outward				Def 'n L/150
	0	1	2	3	0	1	2	3	
2000	12.39	12.39	12.39	12.39	12.39	12.39	12.39	12.39	68.00
2500	9.91	9.91	9.91	9.91	9.91	9.91	9.91	9.91	34.82
3000	8.26	8.26	8.26	8.26	8.26	8.26	8.26	8.26	20.15
3500	7.08	7.08	7.08	7.08	7.08	7.08	7.08	7.08	12.69
4000	5.87	6.18	6.18	6.18	4.95	6.18	6.18	6.18	8.50
4500	4.58	4.88	4.88	4.88	3.31	4.88	4.88	4.88	5.97
5000	3.66	3.96	3.96	3.96	2.29	3.94	3.96	3.96	4.35
5500	2.99	3.27	3.27	3.27	1.59	3.13	3.27	3.27	3.27
6000	2.49	2.75	2.75	2.75	1.13	2.51	2.75	2.75	2.52
6500	2.10	2.34	2.34	2.34	0.83	2.03	2.34	2.34	1.98
7000	1.80	2.02	2.02	2.02	0.63	1.65	2.02	2.02	1.59
7500	1.56	1.76	1.76	1.76	0.48	1.32	1.72	1.76	1.29
8000	1.36	1.55	1.55	1.55	0.38	1.05	1.47	1.55	1.06
8500	1.20	1.37	1.37	1.37	0.30	0.85	1.26	1.37	0.89
9000	1.06	1.22	1.22	1.22	0.24	0.69	1.09	1.22	0.75
9500	0.95	1.10	1.10	1.10	0.20	0.55	0.94	1.08	0.64
10000	0.85	0.99	0.99	0.99	0.16	0.45	0.81	0.96	0.54
10500	0.77	0.90	0.90	0.90	0.14	0.37	0.70	0.85	0.47
11000	0.70	0.82	0.82	0.82	0.12	0.31	0.59	0.76	0.41
11500	0.64	0.75	0.75	0.75	0.10	0.26	0.50	0.67	0.36
12000	0.58	0.69	0.69	0.69	0.08	0.22	0.43	0.60	0.32

C/Z250-19									
Span	Inward				Outward				Def 'n L/150
	0	1	2	3	0	1	2	3	
2500	20.21	20.21	20.21	20.21	20.21	20.21	20.21	20.21	45.55
3000	15.13	15.57	15.57	15.57	15.33	15.57	15.57	15.57	26.36
3500	10.67	11.44	11.44	11.44	10.07	11.44	11.44	11.44	16.60
4000	7.91	8.76	8.76	8.76	6.77	8.76	8.76	8.76	11.12
4500	6.09	6.92	6.92	6.92	4.41	6.92	6.92	6.92	7.81
5000	4.82	5.60	5.60	5.60	2.94	5.60	5.60	5.60	5.69
5500	3.91	4.63	4.63	4.63	2.04	4.51	4.63	4.63	4.28
6000	3.23	3.89	3.89	3.89	1.46	3.55	3.89	3.89	3.30
6500	2.71	3.32	3.32	3.32	1.08	2.84	3.32	3.32	2.59
7000	2.31	2.86	2.86	2.86	0.82	2.27	2.86	2.86	2.08
7500	1.98	2.49	2.49	2.49	0.63	1.80	2.49	2.49	1.69
8000	1.72	2.19	2.19	2.19	0.50	1.40	2.11	2.19	1.39
8500	1.51	1.94	1.94	1.94	0.40	1.11	1.79	1.94	1.16
9000	1.33	1.73	1.73	1.73	0.32	0.88	1.52	1.73	0.98
9500	1.19	1.55	1.55	1.55	0.27	0.72	1.30	1.55	0.83
10000	1.06	1.40	1.40	1.40	0.22	0.59	1.12	1.39	0.71
10500	0.95	1.27	1.27	1.27	0.19	0.49	0.95	1.22	0.62
11000	0.86	1.16	1.16	1.16	0.16	0.41	0.80	1.07	0.54
11500	0.78	1.06	1.06	1.06	0.13	0.34	0.67	0.95	0.47
12000	0.71	0.97	0.97	0.97	0.12	0.29	0.57	0.84	0.41

C/Z250-24									
Span	Inward				Outward				Def 'n L/150
	0	1	2	3	0	1	2	3	
3000	19.61	21.75	21.75	21.75	20.80	21.75	21.75	21.75	34.11
3500	13.66	15.98	15.98	15.98	13.62	15.98	15.98	15.98	21.48
4000	10.00	12.23	12.23	12.23	8.78	12.23	12.23	12.23	14.39
4500	7.53	9.67	9.67	9.67	5.62	9.67	9.67	9.67	10.11
5000	5.84	7.83	7.83	7.83	3.76	7.80	7.83	7.83	7.37
5500	4.65	6.47	6.47	6.47	2.62	6.14	6.47	6.47	5.54
6000	3.77	5.44	5.44	5.44	1.89	4.84	5.44	5.44	4.26
6500	3.12	4.63	4.63	4.63	1.41	3.84	4.63	4.63	3.35
7000	2.62	4.00	4.00	4.00	1.07	2.99	4.00	4.00	2.69
7500	2.23	3.48	3.48	3.48	0.83	2.31	3.40	3.48	2.18
8000	1.92	3.03	3.06	3.06	0.66	1.80	2.87	3.06	1.80
8500	1.67	2.66	2.71	2.71	0.53	1.42	2.43	2.71	1.50
9000	1.47	2.36	2.42	2.42	0.44	1.14	2.07	2.42	1.26
9500	1.30	2.10	2.17	2.17	0.36	0.93	1.75	2.14	1.07
10000	1.15	1.88	1.96	1.96	0.30	0.76	1.47	1.89	0.92
10500	1.03	1.69	1.78	1.78	0.26	0.63	1.23	1.66	0.80
11000	0.93	1.53	1.62	1.62	0.22	0.53	1.03	1.46	0.69
11500	0.84	1.39	1.48	1.48	0.19	0.45	0.86	1.29	0.61
12000	0.77	1.27	1.36	1.36	0.16	0.38	0.73	1.14	0.53

**NOTE:** Bolting of section sizes from 100 to 250mm inclusive requires M12 grade 4.6 bolts. 300mm and 350mm sections require M16 grade 4.6 bolts. Shaded values require grade 8.8 bolts.



# DESIGN CAPACITY TABLES

Single spans are simply supported at each end of the purlin.

(Tables in kN/m)



# 1 SINGLE

C/Z300-19									
Span	Inward				Outward				Def 'n L/150
	0	1	2	3	0	1	2	3	
4000	10.42	10.42	10.42	10.42	10.42	10.42	10.42	10.42	19.45
4500	8.31	9.27	9.27	9.27	8.28	9.27	9.27	9.27	13.66
5000	6.56	7.56	7.56	7.56	6.20	7.56	7.56	7.56	9.96
5500	5.30	6.25	6.25	6.25	4.48	6.25	6.25	6.25	7.48
6000	4.36	5.25	5.25	5.25	3.29	5.25	5.25	5.25	5.76
6500	3.64	4.47	4.47	4.47	2.48	4.42	4.47	4.47	4.53
7000	3.08	3.86	3.86	3.86	1.87	3.70	3.86	3.86	3.63
7500	2.62	3.36	3.36	3.36	1.43	3.12	3.36	3.36	2.95
8000	2.25	2.95	2.95	2.95	1.12	2.64	2.95	2.95	2.43
8500	1.95	2.62	2.62	2.62	0.89	2.25	2.62	2.62	2.03
9000	1.71	2.33	2.33	2.33	0.71	1.91	2.33	2.33	1.71
9500	1.51	2.09	2.09	2.09	0.58	1.59	2.06	2.06	1.45
10000	1.34	1.88	1.89	1.89	0.48	1.32	1.82	1.82	1.25
10500	1.20	1.69	1.71	1.71	0.40	1.11	1.61	1.61	1.08
11000	1.08	1.53	1.56	1.56	0.33	0.94	1.43	1.43	0.94
11500	0.98	1.40	1.43	1.43	0.28	0.80	1.28	1.28	0.82
12000	0.89	1.28	1.31	1.31	0.24	0.68	1.14	1.14	0.72

C/Z300-24									
Span	Inward				Outward				Def 'n L/150
	0	1	2	3	0	1	2	3	
4000	14.16	16.59	16.59	16.59	15.71	16.59	16.59	16.59	25.37
4500	10.59	13.11	13.11	13.11	11.28	13.11	13.11	13.11	17.82
5000	8.19	10.62	10.62	10.62	8.20	10.62	10.62	10.62	12.99
5500	6.49	8.78	8.78	8.78	5.99	8.78	8.78	8.78	9.76
6000	5.26	7.37	7.37	7.37	4.30	7.37	7.37	7.37	7.52
6500	4.32	6.28	6.28	6.28	3.16	6.28	6.28	6.28	5.91
7000	3.61	5.42	5.42	5.42	2.38	5.25	5.42	5.42	4.73
7500	3.05	4.72	4.72	4.72	1.83	4.36	4.72	4.72	3.85
8000	2.61	4.15	4.15	4.15	1.43	3.63	4.15	4.15	3.17
8500	2.26	3.67	3.67	3.67	1.14	3.02	3.67	3.67	2.64
9000	1.97	3.28	3.28	3.28	0.92	2.54	3.28	3.28	2.23
9500	1.73	2.91	2.94	2.94	0.75	2.13	2.94	2.94	1.89
10000	1.53	2.59	2.65	2.65	0.62	1.78	2.58	2.58	1.62
10500	1.37	2.32	2.41	2.41	0.52	1.47	2.26	2.26	1.40
11000	1.23	2.09	2.19	2.19	0.44	1.23	1.99	1.99	1.22
11500	1.11	1.90	2.01	2.01	0.37	1.03	1.75	1.75	1.07
12000	1.00	1.73	1.84	1.84	0.32	0.87	1.54	1.54	0.94

C/Z300-30									
Span	Inward				Outward				Def 'n L/150
	0	1	2	3	0	1	2	3	
4000	18.65	23.61	23.61	23.61	21.91	23.61	23.61	23.61	32.78
4500	13.48	18.66	18.66	18.66	15.89	18.66	18.66	18.66	23.03
5000	10.03	15.11	15.11	15.11	11.27	15.11	15.11	15.11	16.79
5500	7.69	12.49	12.49	12.49	7.92	12.49	12.49	12.49	12.61
6000	6.07	10.50	10.50	10.50	5.67	10.50	10.50	10.50	9.71
6500	4.91	8.94	8.94	8.94	4.18	8.73	8.94	8.94	7.64
7000	4.05	7.65	7.71	7.71	3.16	7.30	7.71	7.71	6.12
7500	3.40	6.56	6.72	6.72	2.44	6.13	6.72	6.72	4.97
8000	2.89	5.69	5.90	5.90	1.92	5.13	5.90	5.90	4.10
8500	2.49	4.97	5.23	5.23	1.53	4.26	5.23	5.23	3.42
9000	2.16	4.37	4.66	4.66	1.24	3.52	4.62	4.62	2.88
9500	1.90	3.87	4.19	4.19	1.02	2.89	4.06	4.06	2.45
10000	1.68	3.45	3.78	3.78	0.85	2.38	3.58	3.58	2.10
10500	1.50	3.08	3.43	3.43	0.71	1.97	3.17	3.17	1.81
11000	1.34	2.77	3.10	3.10	0.60	1.64	2.80	2.80	1.58
11500	1.21	2.50	2.81	2.81	0.52	1.38	2.48	2.48	1.38
12000	1.09	2.27	2.56	2.56	0.44	1.17	2.18	2.19	1.21
12500	1.00	2.06	2.34	2.34	0.39	1.00	1.91	1.92	1.07
13000	0.91	1.89	2.14	2.14	0.34	0.86	1.67	1.68	0.96
13500	0.83	1.73	1.97	1.97	0.30	0.75	1.45	1.47	0.85
14000	0.77	1.58	1.82	1.82	0.26	0.65	1.26	1.28	0.77

**NOTE:** Bolting of section sizes from 100 to 250mm inclusive requires M12 grade 4.6 bolts. 300mm and 350mm sections require M16 grade 4.6 bolts. Shaded values require grade 8.8 bolts.

# 1 SINGLE



## DESIGN CAPACITY TABLES

Single spans are simply supported at each end of the purlin.

(Tables in kN/m)

C/Z350-19									
Span	Inward				Outward				Def 'n L/150
	0	1	2	3	0	1	2	3	
4000	8.87	8.87	8.87	8.87	8.87	8.87	8.87	8.87	31.73
4500	7.89	7.89	7.89	7.89	7.89	7.89	7.89	7.89	22.29
5000	7.10	7.10	7.10	7.10	7.10	7.10	7.10	7.10	16.25
5500	6.45	6.45	6.45	6.45	6.45	6.45	6.45	6.45	12.21
6000	5.64	5.92	5.92	5.92	5.76	5.92	5.92	5.92	9.40
6500	4.67	5.46	5.46	5.46	4.58	5.46	5.46	5.46	7.40
7000	3.93	4.99	4.99	4.99	3.63	4.99	4.99	4.99	5.92
7500	3.34	4.35	4.35	4.35	2.92	4.35	4.35	4.35	4.81
8000	2.86	3.82	3.82	3.82	2.31	3.77	3.82	3.82	3.97
8500	2.48	3.39	3.39	3.39	1.85	3.27	3.39	3.39	3.31
9000	2.17	3.02	3.02	3.02	1.51	2.85	3.02	3.02	2.79
9500	1.92	2.70	2.71	2.71	1.24	2.49	2.71	2.71	2.37
10000	1.71	2.42	2.45	2.45	1.03	2.18	2.45	2.45	2.03
10500	1.53	2.18	2.22	2.22	0.86	1.92	2.22	2.22	1.75
11000	1.38	1.97	2.02	2.02	0.72	1.69	2.02	2.02	1.53
11500	1.25	1.79	1.85	1.85	0.61	1.49	1.82	1.82	1.34
12000	1.13	1.64	1.70	1.70	0.52	1.31	1.65	1.65	1.18
12500	1.03	1.50	1.57	1.57	0.44	1.15	1.50	1.50	1.04
13000	0.94	1.38	1.45	1.45	0.38	1.01	1.36	1.36	0.92
13500	0.86	1.27	1.34	1.34	0.33	0.90	1.24	1.24	0.83
14000	0.79	1.18	1.25	1.25	0.29	0.78	1.13	1.13	0.74

C/Z350-24									
Span	Inward				Outward				Def 'n L/150
	0	1	2	3	0	1	2	3	
4000	17.94	17.94	17.94	17.94	17.94	17.94	17.94	17.94	41.25
4500	15.20	15.94	15.94	15.94	15.94	15.94	15.94	15.94	28.97
5000	11.83	13.80	13.80	13.80	13.13	13.80	13.80	13.80	21.12
5500	9.22	11.40	11.40	11.40	10.35	11.40	11.40	11.40	15.87
6000	7.30	9.58	9.58	9.58	8.22	9.58	9.58	9.58	12.22
6500	5.89	8.16	8.16	8.16	6.33	8.16	8.16	8.16	9.61
7000	4.84	7.04	7.04	7.04	4.87	7.04	7.04	7.04	7.70
7500	4.05	6.13	6.13	6.13	3.81	6.13	6.13	6.13	6.26
8000	3.44	5.39	5.39	5.39	3.03	5.38	5.39	5.39	5.16
8500	2.95	4.77	4.77	4.77	2.48	4.67	4.77	4.77	4.30
9000	2.56	4.26	4.26	4.26	1.99	4.07	4.26	4.26	3.62
9500	2.24	3.80	3.82	3.82	1.62	3.56	3.82	3.82	3.08
10000	1.98	3.39	3.45	3.45	1.33	3.12	3.45	3.45	2.64
10500	1.76	3.05	3.13	3.13	1.10	2.75	3.13	3.13	2.28
11000	1.58	2.75	2.85	2.85	0.92	2.42	2.85	2.85	1.98
11500	1.43	2.50	2.61	2.61	0.78	2.09	2.60	2.61	1.74
12000	1.29	2.27	2.40	2.40	0.66	1.80	2.35	2.38	1.53
12500	1.18	2.08	2.21	2.21	0.57	1.55	2.14	2.16	1.35
13000	1.08	1.91	2.04	2.04	0.49	1.35	1.94	1.96	1.20
13500	0.99	1.76	1.89	1.89	0.43	1.18	1.77	1.79	1.07
14000	0.91	1.62	1.76	1.76	0.37	1.03	1.61	1.63	0.96
14500	0.84	1.50	1.64	1.64	0.33	0.91	1.48	1.49	0.87
15000	0.77	1.39	1.52	1.53	0.29	0.82	1.35	1.36	0.78

C/Z350-30									
Span	Inward				Outward				Def 'n L/150
	0	1	2	3	0	1	2	3	
4000	26.31	30.00	30.00	30.00	30.00	30.00	30.00	30.00	53.34
4500	19.29	23.71	23.71	23.71	23.57	23.71	23.71	23.71	37.46
5000	14.46	19.20	19.20	19.20	17.97	19.20	19.20	19.20	27.31
5500	11.19	15.87	15.87	15.87	13.82	15.87	15.87	15.87	20.52
6000	8.87	13.33	13.33	13.33	10.66	13.33	13.33	13.33	15.81
6500	7.12	11.36	11.36	11.36	8.25	11.36	11.36	11.36	12.43
7000	5.83	9.80	9.80	9.80	6.48	9.80	9.80	9.80	9.95
7500	4.82	8.53	8.53	8.53	5.08	8.53	8.53	8.53	8.09
8000	4.04	7.50	7.50	7.50	3.97	7.50	7.50	7.50	6.67
8500	3.43	6.64	6.64	6.64	3.15	6.48	6.64	6.64	5.56
9000	2.95	5.88	5.93	5.93	2.53	5.59	5.93	5.93	4.68
9500	2.57	5.18	5.32	5.32	2.06	4.83	5.32	5.32	3.98
10000	2.25	4.60	4.80	4.80	1.70	4.18	4.80	4.80	3.41
10500	1.99	4.10	4.35	4.35	1.41	3.62	4.35	4.35	2.95
11000	1.77	3.67	3.97	3.97	1.19	3.13	3.97	3.97	2.57
11500	1.58	3.30	3.63	3.63	1.00	2.71	3.63	3.63	2.25
12000	1.43	2.98	3.33	3.33	0.86	2.37	3.28	3.28	1.98
12500	1.29	2.70	3.07	3.07	0.74	2.07	2.95	2.95	1.75
13000	1.18	2.46	2.84	2.84	0.64	1.80	2.66	2.66	1.55
13500	1.07	2.25	2.63	2.63	0.56	1.58	2.41	2.41	1.39
14000	0.98	2.06	2.44	2.44	0.49	1.37	2.17	2.17	1.24
14500	0.91	1.89	2.25	2.25	0.43	1.20	1.97	1.97	1.12
15000	0.84	1.74	2.08	2.08	0.38	1.05	1.78	1.78	1.01

**NOTE:** Bolting of section sizes from 100 to 250mm inclusive requires M12 grade 4.6 bolts. 300mm and 350mm sections require M16 grade 4.6 bolts. Shaded values require grade 8.8 bolts.

# DESIGN CAPACITY TABLES

Two continuous spans are continuous over two bays of equal span, supported at each end of the purlin and over a central support.

(Tables in kN/m)



# 2 CONTINUOUS

C/Z150-10									
Span	Inward				Outward				Def 'n L/150
	0	1	2	3	0	1	2	3	
2500	3.43	3.43	3.43	3.43	3.43	3.43	3.43	3.43	14.69
3000	2.70	2.70	2.70	2.70	2.70	2.70	2.70	2.70	8.50
3500	2.18	2.18	2.18	2.18	2.18	2.18	2.18	2.18	5.35
4000	1.79	1.79	1.79	1.79	1.79	1.79	1.79	1.79	3.59
4500	1.50	1.50	1.50	1.50	1.50	1.50	1.50	1.50	2.52
5000	1.27	1.27	1.27	1.27	1.27	1.27	1.27	1.27	1.84
5500	1.08	1.08	1.08	1.08	0.98	1.08	1.08	1.08	1.38
6000	0.91	0.94	0.94	0.94	0.77	0.94	0.94	0.94	1.06
6500	0.76	0.81	0.81	0.81	0.60	0.78	0.81	0.81	0.84
7000	0.64	0.69	0.69	0.69	0.46	0.65	0.69	0.69	0.67
7500	0.55	0.61	0.61	0.61	0.36	0.54	0.61	0.61	0.54
8000	0.47	0.53	0.53	0.53	0.29	0.45	0.53	0.53	0.45
8500	0.41	0.47	0.47	0.47	0.23	0.37	0.46	0.47	0.37
9000	0.36	0.42	0.42	0.42	0.19	0.31	0.40	0.42	0.32

C/Z150-12									
Span	Inward				Outward				Def 'n L/150
	0	1	2	3	0	1	2	3	
2500	5.32	5.32	5.32	5.32	5.32	5.32	5.32	5.32	18.34
3000	4.07	4.07	4.07	4.07	4.07	4.07	4.07	4.07	10.61
3500	3.20	3.20	3.20	3.20	3.20	3.20	3.20	3.20	6.68
4000	2.58	2.58	2.58	2.58	2.58	2.58	2.58	2.58	4.48
4500	2.08	2.08	2.08	2.08	2.08	2.08	2.08	2.08	3.14
5000	1.68	1.68	1.68	1.68	1.64	1.68	1.68	1.68	2.29
5500	1.38	1.39	1.39	1.39	1.26	1.39	1.39	1.39	1.72
6000	1.14	1.17	1.17	1.17	0.98	1.17	1.17	1.17	1.33
6500	0.95	1.00	1.00	1.00	0.76	1.00	1.00	1.00	1.04
7000	0.80	0.86	0.86	0.86	0.58	0.84	0.86	0.86	0.84
7500	0.68	0.75	0.75	0.75	0.46	0.69	0.75	0.75	0.68
8000	0.58	0.66	0.66	0.66	0.36	0.57	0.66	0.66	0.56
8500	0.50	0.58	0.58	0.58	0.29	0.48	0.58	0.58	0.47
9000	0.43	0.52	0.52	0.52	0.24	0.39	0.52	0.52	0.39

C/Z150-15									
Span	Inward				Outward				Def 'n L/150
	0	1	2	3	0	1	2	3	
2500	8.03	8.03	8.03	8.03	8.03	8.03	8.03	8.03	23.34
3000	5.90	5.90	5.90	5.90	5.90	5.90	5.90	5.90	13.50
3500	4.25	4.38	4.38	4.38	4.38	4.38	4.38	4.38	8.50
4000	3.19	3.35	3.36	3.35	3.36	3.36	3.36	3.36	5.70
4500	2.47	2.65	2.65	2.65	2.57	2.65	2.65	2.65	4.00
5000	1.97	2.15	2.15	2.15	1.98	2.15	2.15	2.15	2.92
5500	1.60	1.77	1.77	1.77	1.55	1.77	1.77	1.77	2.19
6000	1.32	1.49	1.49	1.49	1.24	1.49	1.49	1.49	1.69
6500	1.11	1.27	1.27	1.27	0.99	1.22	1.27	1.27	1.33
7000	0.94	1.10	1.10	1.10	0.78	1.02	1.10	1.10	1.06
7500	0.81	0.95	0.95	0.95	0.61	0.85	0.95	0.95	0.86
8000	0.70	0.84	0.84	0.84	0.48	0.72	0.84	0.84	0.71
8500	0.61	0.74	0.74	0.74	0.39	0.61	0.73	0.74	0.59
9000	0.53	0.66	0.66	0.66	0.32	0.52	0.63	0.66	0.50
9500	0.46	0.60	0.60	0.60	0.26	0.43	0.55	0.60	0.43
10000	0.41	0.54	0.54	0.54	0.22	0.36	0.48	0.54	0.37

C/Z150-19									
Span	Inward				Outward				Def 'n L/150
	0	1	2	3	0	1	2	3	
2500	11.71	11.91	11.91	11.91	11.91	11.91	11.91	11.91	29.92
3000	7.90	8.27	8.27	8.27	8.27	8.27	8.27	8.27	17.31
3500	5.63	6.08	6.08	6.08	6.08	6.08	6.08	6.08	10.90
4000	4.19	4.65	4.65	4.65	4.64	4.65	4.65	4.65	7.30
4500	3.23	3.68	3.68	3.68	3.53	3.68	3.68	3.68	5.13
5000	2.55	2.98	2.98	2.98	2.70	2.98	2.98	2.98	3.74
5500	2.06	2.46	2.46	2.46	2.09	2.46	2.46	2.46	2.81
6000	1.69	2.07	2.07	2.07	1.64	2.04	2.07	2.07	2.16
6500	1.41	1.76	1.76	1.76	1.29	1.69	1.76	1.76	1.70
7000	1.18	1.52	1.52	1.52	1.02	1.40	1.52	1.52	1.36
7500	1.01	1.32	1.32	1.32	0.81	1.16	1.32	1.32	1.11
8000	0.86	1.16	1.16	1.16	0.64	0.97	1.15	1.16	0.91
8500	0.74	1.03	1.03	1.03	0.52	0.81	1.00	1.03	0.76
9000	0.64	0.92	0.92	0.92	0.43	0.68	0.87	0.92	0.64
9500	0.56	0.83	0.83	0.83	0.36	0.57	0.76	0.83	0.55
10000	0.49	0.74	0.74	0.74	0.30	0.48	0.66	0.74	0.47

C/Z150-24									
Span	Inward				Outward				Def 'n L/150
	0	1	2	3	0	1	2	3	
2500	14.43	15.93	15.93	15.93	15.92	15.93	15.93	15.93	37.94
3000	9.60	11.24	11.24	11.24	11.24	11.24	11.24	11.24	21.95
3500	6.79	8.26	8.26	8.26	8.01	8.26	8.26	8.26	13.75
4000	5.04	6.32	6.32	6.32	5.87	6.32	6.32	6.32	9.21
4500	3.87	4.99	4.99	4.99	4.42	4.99	4.99	4.99	6.47
5000	3.05	4.05	4.05	4.05	3.39	3.97	4.05	4.05	4.72
5500	2.46	3.34	3.34	3.34	2.65	3.19	3.34	3.34	3.54
6000	2.02	2.81	2.81	2.81	2.09	2.59	2.81	2.81	2.73
6500	1.68	2.38	2.39	2.39	1.66	2.13	2.38	2.39	2.15
7000	1.42	2.03	2.06	2.06	1.33	1.77	2.01	2.06	1.72
7500	1.20	1.75	1.80	1.80	1.07	1.48	1.71	1.80	1.40
8000	1.03	1.52	1.58	1.58	0.86	1.24	1.47	1.58	1.15
8500	0.89	1.34	1.40	1.40	0.71	1.05	1.27	1.38	0.96
9000	0.78	1.18	1.25	1.25	0.59	0.89	1.10	1.21	0.81
9500	0.68	1.04	1.12	1.12	0.49	0.75	0.96	1.07	0.69
10000	0.60	0.93	1.01	1.01	0.42	0.64	0.84	0.94	0.59

**NOTE:** Bolting of section sizes from 100 to 250mm inclusive requires M12 grade 4.6 bolts. 300mm and 350mm sections require M16 grade 4.6 bolts. Shaded values require grade 8.8 bolts.

# 2 CONTINUOUS



## DESIGN CAPACITY TABLES

Two continuous spans are continuous over two bays of equal span, supported at each end of the purlin and over a central support.

(Tables in kN/m)

C/Z200-12									
Span	Inward				Outward				Def 'n L/150
	0	1	2	3	0	1	2	3	
2500	4.63	4.63	4.63	4.63	4.63	4.63	4.63	4.63	38.11
3000	3.71	3.71	3.71	3.71	3.71	3.71	3.71	3.71	22.06
3500	3.05	3.05	3.05	3.05	3.05	3.05	3.05	3.05	13.89
4000	2.55	2.55	2.55	2.55	2.55	2.55	2.55	2.55	9.31
4500	2.16	2.16	2.16	2.16	2.16	2.16	2.16	2.16	6.54
5000	1.86	1.86	1.86	1.86	1.86	1.86	1.86	1.86	4.76
5500	1.61	1.61	1.61	1.61	1.61	1.61	1.61	1.61	3.58
6000	1.41	1.41	1.41	1.41	1.41	1.41	1.41	1.41	2.76
6500	1.24	1.24	1.24	1.24	1.23	1.24	1.24	1.24	2.17
7000	1.08	1.10	1.10	1.10	1.00	1.10	1.10	1.10	1.74
7500	0.93	0.98	0.98	0.98	0.82	0.98	0.98	0.98	1.41
8000	0.80	0.88	0.88	0.88	0.68	0.87	0.88	0.88	1.16
8500	0.70	0.79	0.79	0.79	0.56	0.75	0.79	0.79	0.97
9000	0.61	0.72	0.72	0.72	0.46	0.64	0.72	0.72	0.82
9500	0.54	0.65	0.65	0.65	0.38	0.56	0.65	0.65	0.70
10000	0.48	0.58	0.58	0.58	0.32	0.48	0.57	0.58	0.60

C/Z200-15									
Span	Inward				Outward				Def 'n L/150
	0	1	2	3	0	1	2	3	
2500	8.23	8.23	8.23	8.23	8.23	8.23	8.23	8.23	49.75
3000	6.41	6.41	6.41	6.41	6.41	6.41	6.41	6.41	28.79
3500	5.13	5.13	5.13	5.13	5.13	5.13	5.13	5.13	18.13
4000	4.18	4.18	4.19	4.19	4.19	4.19	4.19	4.19	12.15
4500	3.47	3.47	3.47	3.47	3.47	3.47	3.47	3.47	8.53
5000	2.92	2.92	2.92	2.92	2.92	2.92	2.92	2.92	6.22
5500	2.40	2.49	2.49	2.49	2.49	2.49	2.49	2.49	4.67
6000	1.97	2.12	2.12	2.12	2.12	2.06	2.12	2.12	3.60
6500	1.65	1.81	1.81	1.81	1.67	1.81	1.81	1.81	2.83
7000	1.40	1.56	1.56	1.56	1.36	1.56	1.56	1.56	2.27
7500	1.19	1.36	1.36	1.36	1.10	1.36	1.36	1.36	1.84
8000	1.03	1.19	1.19	1.19	0.90	1.19	1.19	1.19	1.52
8500	0.89	1.06	1.06	1.06	0.73	1.03	1.06	1.06	1.27
9000	0.78	0.94	0.94	0.94	0.60	0.88	0.94	0.94	1.07
9500	0.68	0.85	0.85	0.85	0.50	0.76	0.85	0.85	0.91
10000	0.60	0.76	0.76	0.76	0.43	0.65	0.76	0.76	0.78

C/Z200-19									
Span	Inward				Outward				Def 'n L/150
	0	1	2	3	0	1	2	3	
3500	8.49	8.59	8.59	8.59	8.59	8.59	8.59	8.59	23.97
4000	6.30	6.86	6.86	6.86	6.86	6.86	6.86	6.86	16.06
4500	4.85	5.53	5.53	5.53	5.53	5.53	5.53	5.53	11.28
5000	3.84	4.48	4.48	4.48	4.45	4.48	4.48	4.48	8.22
5500	3.11	3.70	3.70	3.70	3.53	3.70	3.70	3.70	6.18
6000	2.57	3.11	3.11	3.11	2.84	3.11	3.11	3.11	4.76
6500	2.15	2.65	2.65	2.65	2.31	2.65	2.65	2.65	3.74
7000	1.82	2.28	2.28	2.28	1.91	2.28	2.28	2.28	3.00
7500	1.56	1.99	1.99	1.99	1.58	1.95	1.99	1.99	2.44
8000	1.35	1.75	1.75	1.75	1.31	1.67	1.75	1.75	2.01
8500	1.17	1.55	1.55	1.55	1.06	1.43	1.55	1.55	1.67
9000	1.02	1.38	1.38	1.38	0.86	1.23	1.38	1.38	1.41
9500	0.89	1.24	1.24	1.24	0.71	1.07	1.24	1.24	1.20
10000	0.78	1.12	1.12	1.12	0.59	0.93	1.10	1.12	1.03
10500	0.68	1.02	1.02	1.02	0.49	0.81	0.98	1.02	0.89
11000	0.60	0.93	0.93	0.93	0.42	0.71	0.87	0.93	0.77

C/Z200-24									
Span	Inward				Outward				Def 'n L/150
	0	1	2	3	0	1	2	3	
3500	11.23	11.38	11.38	11.38	11.38	11.38	11.38	11.38	30.61
4000	8.23	9.69	9.69	9.69	9.69	9.69	9.69	9.69	20.51
4500	6.23	7.66	7.66	7.66	7.66	7.66	7.66	7.66	14.40
5000	4.85	6.20	6.20	6.20	6.05	6.20	6.20	6.20	10.50
5500	3.87	5.13	5.13	5.13	4.82	5.13	5.13	5.13	7.89
6000	3.14	4.31	4.31	4.31	3.88	4.31	4.31	4.31	6.08
6500	2.59	3.67	3.67	3.67	3.14	3.67	3.67	3.67	4.78
7000	2.17	3.16	3.16	3.16	2.54	3.13	3.16	3.16	3.83
7500	1.83	2.76	2.76	2.76	2.06	2.67	2.76	2.76	3.11
8000	1.56	2.42	2.42	2.42	1.68	2.28	2.42	2.42	2.56
8500	1.34	2.15	2.15	2.15	1.37	1.96	2.15	2.15	2.14
9000	1.16	1.91	1.91	1.91	1.12	1.69	1.91	1.91	1.80
9500	1.02	1.72	1.72	1.72	0.92	1.46	1.70	1.72	1.53
10000	0.89	1.54	1.55	1.55	0.77	1.25	1.51	1.55	1.31
10500	0.79	1.39	1.41	1.41	0.65	1.08	1.34	1.41	1.13
11000	0.70	1.26	1.28	1.28	0.55	0.93	1.20	1.28	0.99

**NOTE:** Bolting of section sizes from 100 to 250mm inclusive requires M12 grade 4.6 bolts. 300mm and 350mm sections require M16 grade 4.6 bolts. Shaded values require grade 8.8 bolts.

# DESIGN CAPACITY TABLES

Two continuous spans are continuous over two bays of equal span, supported at each end of the purlin and over a central support.

(Tables in kN/m)



# 2 CONTINUOUS

C/Z250-15									
Span	Inward				Outward				Def 'n L/150
	0	1	2	3	0	1	2	3	
2500	7.28	7.28	7.28	7.28	7.28	7.28	7.28	7.28	83.96
3000	5.86	5.86	5.86	5.86	5.86	5.86	5.86	5.86	48.58
3500	4.84	4.84	4.84	4.84	4.84	4.84	4.84	4.84	30.59
4000	4.07	4.07	4.07	4.07	4.07	4.07	4.07	4.07	20.50
4500	3.47	3.47	3.47	3.47	3.47	3.47	3.47	3.47	14.40
5000	3.00	3.00	3.00	3.00	3.00	3.00	3.00	3.00	10.49
5500	2.61	2.61	2.61	2.61	2.61	2.61	2.61	2.61	7.88
6000	2.29	2.29	2.29	2.29	2.29	2.29	2.29	2.29	6.07
6500	2.03	2.03	2.03	2.03	2.03	2.03	2.03	2.03	4.78
7000	1.77	1.80	1.80	1.80	1.79	1.80	1.80	1.80	3.82
7500	1.52	1.61	1.61	1.61	1.48	1.61	1.61	1.61	3.11
8000	1.32	1.45	1.45	1.45	1.24	1.45	1.45	1.45	2.56
8500	1.15	1.31	1.31	1.31	1.02	1.31	1.31	1.31	2.14
9000	1.01	1.19	1.19	1.19	0.83	1.14	1.19	1.19	1.80
9500	0.89	1.08	1.08	1.08	0.70	0.99	1.08	1.08	1.53
10000	0.79	0.99	0.99	0.99	0.59	0.87	0.99	0.99	1.31

C/Z250-19									
Span	Inward				Outward				Def 'n L/150
	0	1	2	3	0	1	2	3	
2500	12.61	12.61	12.61	12.61	12.61	12.61	12.61	12.61	109.84
3000	10.51	10.51	10.51	10.51	10.51	10.51	10.51	10.51	63.57
3500	8.78	8.78	8.78	8.78	8.78	8.78	8.78	8.78	40.03
4000	7.23	7.23	7.23	7.23	7.23	7.23	7.23	7.23	26.82
4500	6.05	6.05	6.05	6.05	6.05	6.05	6.05	6.05	18.84
5000	4.94	5.12	5.12	5.12	5.12	5.12	5.12	5.12	13.73
5500	3.98	4.39	4.39	4.39	4.39	4.39	4.39	4.39	10.32
6000	3.27	3.80	3.80	3.80	3.77	3.80	3.80	3.80	7.95
6500	2.72	3.31	3.31	3.31	3.04	3.31	3.31	3.31	6.25
7000	2.30	2.86	2.86	2.86	2.49	2.86	2.86	2.86	5.00
7500	1.96	2.49	2.49	2.49	2.05	2.49	2.49	2.49	4.07
8000	1.68	2.19	2.19	2.19	1.69	2.19	2.19	2.19	3.35
8500	1.46	1.94	1.94	1.94	1.38	1.90	1.94	1.94	2.80
9000	1.26	1.73	1.73	1.73	1.11	1.63	1.73	1.73	2.35
9500	1.10	1.55	1.55	1.55	0.91	1.40	1.55	1.55	2.00
10000	0.97	1.40	1.40	1.40	0.75	1.21	1.40	1.40	1.72

C/Z250-24									
Span	Inward				Outward				Def 'n L/150
	0	1	2	3	0	1	2	3	
3000	13.27	13.27	13.27	13.27	13.27	13.27	13.27	13.27	82.06
3500	11.38	11.38	11.38	11.38	11.38	11.38	11.38	11.38	51.68
4000	9.95	9.95	9.95	9.95	9.95	9.95	9.95	9.95	34.70
4500	8.01	8.85	8.85	8.85	8.85	8.85	8.85	8.85	24.37
5000	6.21	7.83	7.83	7.83	7.83	7.83	7.83	7.83	17.77
5500	4.91	6.47	6.47	6.47	6.36	6.47	6.47	6.47	13.35
6000	3.96	5.44	5.44	5.44	5.11	5.44	5.44	5.44	10.28
6500	3.24	4.63	4.63	4.63	4.13	4.63	4.63	4.63	8.09
7000	2.69	4.00	4.00	4.00	3.36	4.00	4.00	4.00	6.47
7500	2.26	3.48	3.48	3.48	2.72	3.48	3.48	3.48	5.26
8000	1.92	3.06	3.06	3.06	2.19	3.01	3.06	3.06	4.34
8500	1.65	2.71	2.71	2.71	1.76	2.58	2.71	2.71	3.62
9000	1.43	2.42	2.42	2.42	1.43	2.22	2.42	2.42	3.05
9500	1.25	2.17	2.17	2.17	1.17	1.91	2.17	2.17	2.59
10000	1.09	1.96	1.96	1.96	0.98	1.65	1.96	1.96	2.22
10500	0.97	1.78	1.78	1.78	0.82	1.42	1.77	1.78	1.92
11000	0.86	1.62	1.62	1.62	0.69	1.22	1.58	1.62	1.67
11500	0.77	1.48	1.48	1.48	0.59	1.04	1.41	1.48	1.46
12000	0.69	1.35	1.36	1.36	0.51	0.88	1.26	1.36	1.29

**NOTE:** Bolting of section sizes from 100 to 250mm inclusive requires M12 grade 4.6 bolts. 300mm and 350mm sections require M16 grade 4.6 bolts. Shaded values require grade 8.8 bolts.

# 2 CONTINUOUS

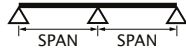

## DESIGN CAPACITY TABLES

Two continuous spans are continuous over two bays of equal span, supported at each end of the purlin and over a central support.

(Tables in kN/m)

C/Z300-19									
Span	Inward				Outward				Def 'n L/150
	0	1	2	3	0	1	2	3	
2500	12.46	12.46	12.46	12.46	12.46	12.46	12.46	12.46	191.59
3000	10.10	10.10	10.10	10.10	10.10	10.10	10.10	10.10	110.88
3500	8.40	8.40	8.40	8.40	8.40	8.40	8.40	8.40	69.82
4000	7.11	7.11	7.11	7.11	7.11	7.11	7.11	7.11	46.77
4500	6.10	6.10	6.10	6.10	6.10	6.10	6.10	6.10	32.85
5000	5.29	5.29	5.29	5.29	5.29	5.29	5.29	5.29	23.95
5500	4.63	4.63	4.63	4.63	4.63	4.63	4.63	4.63	17.99
6000	4.09	4.09	4.09	4.09	4.09	4.09	4.09	4.09	13.86
6500	3.63	3.63	3.63	3.63	3.63	3.63	3.63	3.63	10.90
7000	3.17	3.25	3.25	3.25	3.25	3.25	3.25	3.25	8.73
7500	2.71	2.92	2.92	2.92	2.92	2.92	2.92	2.92	7.10
8000	2.31	2.63	2.63	2.63	2.63	2.63	2.63	2.63	5.85
8500	1.99	2.39	2.39	2.39	2.37	2.39	2.39	2.39	4.88
9000	1.73	2.17	2.17	2.17	2.04	2.17	2.17	2.17	4.11
9500	1.51	1.99	1.99	1.99	1.77	1.99	1.99	1.99	3.49
10000	1.33	1.82	1.82	1.82	1.53	1.82	1.82	1.82	2.99
10500	1.18	1.67	1.67	1.67	1.30	1.67	1.67	1.67	2.59
11000	1.06	1.55	1.55	1.55	1.11	1.49	1.55	1.55	2.25
11500	0.95	1.43	1.43	1.43	0.95	1.34	1.43	1.43	1.97
12000	0.85	1.31	1.31	1.31	0.82	1.20	1.31	1.31	1.73

C/Z300-24									
Span	Inward				Outward				Def 'n L/150
	0	1	2	3	0	1	2	3	
4000	12.79	12.79	12.79	12.79	12.79	12.79	12.79	12.79	61.03
4500	10.77	10.77	10.77	10.77	10.77	10.77	10.77	10.77	42.87
5000	8.79	9.15	9.15	9.15	9.15	9.15	9.15	9.15	31.25
5500	6.97	7.92	7.92	7.92	7.92	7.92	7.92	7.92	23.48
6000	5.63	6.89	6.89	6.89	6.89	6.89	6.89	6.89	18.08
6500	4.63	6.04	6.04	6.04	6.04	6.04	6.04	6.04	14.22
7000	3.85	5.33	5.33	5.33	5.33	5.33	5.33	5.33	11.39
7500	3.24	4.72	4.72	4.72	4.55	4.72	4.72	4.72	9.26
8000	2.76	4.15	4.15	4.15	3.83	4.15	4.15	4.15	7.63
8500	2.37	3.67	3.67	3.67	3.24	3.67	3.67	3.67	6.36
9000	2.05	3.28	3.28	3.28	2.75	3.28	3.28	3.28	5.36
9500	1.79	2.94	2.94	2.94	2.35	2.94	2.94	2.94	4.56
10000	1.57	2.65	2.65	2.65	2.01	2.65	2.66	2.66	3.91
10500	1.39	2.41	2.41	2.41	1.73	2.38	2.41	2.41	3.37
11000	1.23	2.19	2.19	2.19	1.48	2.11	2.19	2.19	2.94
11500	1.10	2.01	2.01	2.01	1.25	1.87	2.01	2.01	2.57
12000	0.99	1.84	1.84	1.84	1.07	1.66	1.84	1.84	2.26

C/Z300-30									
Span	Inward				Outward				Def 'n L/150
	0	1	2	3	0	1	2	3	
4000	20.67	20.98	20.98	20.98	20.98	20.98	20.98	20.98	78.87
4500	15.32	17.33	17.33	17.33	17.33	17.33	17.33	17.33	55.39
5000	11.52	14.52	14.52	14.52	14.52	14.52	14.52	14.52	40.38
5500	8.86	12.33	12.33	12.33	12.33	12.33	12.33	12.33	30.34
6000	6.95	10.49	10.49	10.49	10.49	10.49	10.49	10.49	23.37
6500	5.56	8.94	8.94	8.94	8.86	8.94	8.94	8.94	18.38
7000	4.54	7.71	7.71	7.71	7.44	7.71	7.71	7.71	14.72
7500	3.78	6.72	6.72	6.72	6.30	6.72	6.72	6.72	11.97
8000	3.18	5.90	5.90	5.90	5.35	5.90	5.90	5.90	9.86
8500	2.72	5.23	5.23	5.23	4.54	5.23	5.23	5.23	8.22
9000	2.35	4.66	4.66	4.66	3.84	4.66	4.66	4.66	6.92
9500	2.04	4.19	4.19	4.19	3.24	4.17	4.19	4.19	5.89
10000	1.79	3.78	3.78	3.78	2.73	3.70	3.78	3.78	5.05
10500	1.59	3.43	3.43	3.43	2.30	3.29	3.43	3.43	4.36
11000	1.41	3.10	3.12	3.12	1.94	2.94	3.12	3.12	3.79
11500	1.26	2.82	2.86	2.86	1.65	2.63	2.86	2.86	3.32
12000	1.13	2.57	2.62	2.62	1.41	2.35	2.62	2.62	2.92

**NOTE:** Bolting of section sizes from 100 to 250mm inclusive requires M12 grade 4.6 bolts. 300mm and 350mm sections require M16 grade 4.6 bolts. Shaded values require grade 8.8 bolts.

# DESIGN CAPACITY TABLES

Two continuous spans are continuous over two bays of equal span, supported at each end of the purlin and over a central support.

(Tables in kN/m)

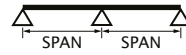

# 2 CONTINUOUS

C/Z350-19									
Span	Inward				Outward				Def 'n L/150
	0	1	2	3	0	1	2	3	
3500	7.64	7.64	7.64	7.64	7.64	7.64	7.64	7.64	113.95
4000	6.57	6.57	6.57	6.57	6.57	6.57	6.57	6.57	76.34
4500	5.73	5.73	5.73	5.73	5.73	5.73	5.73	5.73	53.62
5000	5.06	5.06	5.06	5.06	5.06	5.06	5.06	5.06	39.09
5500	4.50	4.50	4.50	4.50	4.50	4.50	4.50	4.50	29.37
6000	4.03	4.03	4.03	4.03	4.03	4.03	4.03	4.03	22.62
6500	3.64	3.64	3.64	3.64	3.64	3.64	3.64	3.64	17.79
7000	3.30	3.30	3.30	3.30	3.30	3.30	3.30	3.30	14.25
7500	3.00	3.00	3.00	3.00	3.00	3.00	3.00	3.00	11.58
8000	2.75	2.75	2.75	2.75	2.75	2.75	2.75	2.75	9.54
8500	2.52	2.52	2.52	2.52	2.52	2.52	2.52	2.52	7.96
9000	2.27	2.32	2.32	2.32	2.32	2.32	2.32	2.32	6.70
9500	1.99	2.14	2.14	2.14	2.14	2.14	2.14	2.14	5.70
10000	1.76	1.98	1.98	1.98	1.98	1.98	1.98	1.98	4.89
10500	1.57	1.84	1.84	1.84	1.84	1.84	1.84	1.84	4.22
11000	1.41	1.71	1.71	1.71	1.71	1.71	1.71	1.71	3.67
11500	1.27	1.60	1.60	1.60	1.58	1.60	1.60	1.60	3.21
12000	1.15	1.49	1.49	1.49	1.41	1.49	1.49	1.49	2.83

C/Z350-24									
Span	Inward				Outward				Def 'n L/150
	0	1	2	3	0	1	2	3	
4000	12.41	12.41	12.41	12.41	12.41	12.41	12.41	12.41	99.46
4500	10.68	10.68	10.68	10.68	10.68	10.68	10.68	10.68	69.85
5000	9.29	9.29	9.29	9.29	9.29	9.29	9.29	9.29	50.93
5500	8.16	8.16	8.16	8.16	8.16	8.16	8.16	8.16	38.26
6000	7.22	7.22	7.22	7.22	7.22	7.22	7.22	7.22	29.47
6500	6.42	6.42	6.42	6.42	6.42	6.42	6.42	6.42	23.18
7000	5.38	5.75	5.75	5.75	5.75	5.75	5.75	5.75	18.56
7500	4.47	5.18	5.18	5.18	5.18	5.18	5.18	5.18	15.09
8000	3.76	4.68	4.68	4.68	4.68	4.68	4.68	4.68	12.43
8500	3.21	4.25	4.25	4.25	4.25	4.25	4.25	4.25	10.37
9000	2.77	3.88	3.88	3.88	3.88	3.88	3.88	3.88	8.73
9500	2.41	3.55	3.55	3.55	3.55	3.55	3.55	3.55	7.43
10000	2.11	3.26	3.26	3.26	3.22	3.26	3.26	3.26	6.37
10500	1.87	3.00	3.00	3.00	2.85	3.00	3.00	3.00	5.50
11000	1.66	2.77	2.77	2.77	2.53	2.77	2.77	2.77	4.78
11500	1.49	2.57	2.57	2.57	2.25	2.56	2.56	2.56	4.19
12000	1.34	2.38	2.38	2.38	1.99	2.38	2.38	2.38	3.68
12500	1.21	2.21	2.21	2.21	1.74	2.19	2.21	2.21	3.26
13000	1.11	2.04	2.04	2.04	1.53	2.00	2.04	2.04	2.90
13500	1.01	1.89	1.89	1.89	1.34	1.83	1.89	1.89	2.59
14000	0.93	1.76	1.76	1.76	1.18	1.68	1.76	1.76	2.32
14500	0.85	1.64	1.64	1.64	1.05	1.54	1.64	1.64	2.09
15000	0.78	1.53	1.53	1.53	0.93	1.41	1.53	1.53	1.89

C/Z350-30									
Span	Inward				Outward				Def 'n L/150
	0	1	2	3	0	1	2	3	
4000	22.05	22.05	22.05	22.05	22.05	22.05	22.05	22.05	128.33
4500	18.67	18.67	18.67	18.67	18.67	18.67	18.67	18.67	90.13
5000	15.99	15.99	15.99	15.99	15.99	15.99	15.99	15.99	65.71
5500	12.60	13.83	13.83	13.83	13.83	13.83	13.83	13.83	49.37
6000	9.94	12.07	12.07	12.07	12.07	12.07	12.07	12.07	38.03
6500	8.03	10.62	10.62	10.62	10.62	10.62	10.62	10.62	29.91
7000	6.59	9.40	9.40	9.40	9.40	9.40	9.40	9.40	23.95
7500	5.47	8.38	8.38	8.38	8.38	8.38	8.38	8.38	19.47
8000	4.58	7.50	7.50	7.50	7.50	7.50	7.50	7.50	16.04
8500	3.90	6.64	6.64	6.64	6.62	6.64	6.64	6.64	13.37
9000	3.33	5.93	5.93	5.93	5.73	5.93	5.93	5.93	11.27
9500	2.87	5.32	5.32	5.32	4.99	5.32	5.32	5.32	9.58
10000	2.50	4.80	4.80	4.80	4.35	4.80	4.80	4.80	8.21
10500	2.19	4.35	4.35	4.35	3.80	4.35	4.35	4.35	7.10
11000	1.94	3.97	3.97	3.97	3.33	3.97	3.97	3.97	6.17
11500	1.73	3.63	3.63	3.63	2.92	3.63	3.63	3.63	5.40
12000	1.55	3.33	3.33	3.33	2.56	3.33	3.33	3.33	4.75
12500	1.39	3.07	3.07	3.07	2.26	3.07	3.07	3.07	4.21
13000	1.26	2.84	2.84	2.84	2.00	2.79	2.84	2.84	3.74
13500	1.14	2.63	2.63	2.63	1.77	2.53	2.63	2.63	3.34
14000	1.04	2.43	2.45	2.45	1.57	2.30	2.45	2.45	2.99
14500	0.96	2.25	2.28	2.28	1.39	2.09	2.28	2.28	2.69
15000	0.88	2.08	2.13	2.13	1.24	1.91	2.13	2.13	2.43

**NOTE:** Bolting of section sizes from 100 to 250mm inclusive requires M12 grade 4.6 bolts. 300mm and 350mm sections require M16 grade 4.6 bolts. Shaded values require grade 8.8 bolts.

# 2 LAPPED

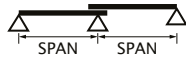

# DESIGN CAPACITY TABLES

Two lapped spans are continuous over two bays, supported at each end of the purlin and lapped over one internal support.

(Tables in kN/m)

Z150-10									
Span	Inward				Outward				Def 'n L/150
	0	1	2	3	0	1	2	3	
2000	5.19	5.20	5.20	5.20	5.19	5.20	5.20	5.20	32.71
2500	4.00	4.00	4.00	4.00	4.00	4.00	4.00	4.00	16.74
3000	3.19	3.19	3.19	3.19	3.19	3.19	3.19	3.19	9.69
3500	2.61	2.61	2.61	2.61	2.61	2.61	2.61	2.61	6.10
4000	2.18	2.18	2.18	2.18	2.18	2.18	2.18	2.18	4.09
4500	1.84	1.84	1.84	1.84	1.84	1.84	1.84	1.84	2.87
5000	1.58	1.58	1.58	1.58	1.58	1.58	1.58	1.58	2.09
5500	1.36	1.36	1.36	1.36	1.24	1.36	1.36	1.36	1.57
6000	1.14	1.19	1.19	1.19	0.93	1.19	1.19	1.19	1.21
6500	0.95	1.04	1.04	1.04	0.70	1.00	1.04	1.04	0.95
7000	0.80	0.92	0.92	0.92	0.54	0.82	0.92	0.92	0.76
7500	0.67	0.82	0.82	0.82	0.42	0.67	0.82	0.82	0.62
8000	0.58	0.72	0.72	0.72	0.34	0.54	0.70	0.72	0.51
8500	0.49	0.64	0.64	0.64	0.27	0.43	0.60	0.64	0.43
9000	0.42	0.57	0.57	0.57	0.22	0.35	0.51	0.57	0.36
9500	0.36	0.51	0.51	0.51	0.18	0.29	0.44	0.51	0.31
10000	0.31	0.46	0.46	0.46	0.15	0.24	0.38	0.45	0.26

Z150-12									
Span	Inward				Outward				Def 'n L/150
	0	1	2	3	0	1	2	3	
2000	8.47	8.47	8.47	8.47	8.47	8.47	8.47	8.47	40.66
2500	6.36	6.36	6.36	6.36	6.36	6.36	6.36	6.36	20.82
3000	4.95	4.95	4.95	4.95	4.95	4.95	4.95	4.95	12.05
3500	3.96	3.96	3.96	3.96	3.96	3.96	3.96	3.96	7.59
4000	3.23	3.23	3.23	3.23	3.23	3.23	3.23	3.23	5.08
4500	2.66	2.68	2.68	2.68	2.68	2.68	2.68	2.68	3.57
5000	2.10	2.25	2.25	2.25	2.09	2.25	2.25	2.25	2.60
5500	1.69	1.88	1.88	1.88	1.58	1.88	1.88	1.88	1.96
6000	1.38	1.58	1.58	1.58	1.19	1.58	1.58	1.58	1.51
6500	1.14	1.35	1.35	1.35	0.90	1.30	1.35	1.35	1.18
7000	0.96	1.16	1.16	1.16	0.69	1.05	1.16	1.16	0.95
7500	0.81	1.01	1.01	1.01	0.54	0.85	1.01	1.01	0.77
8000	0.68	0.89	0.89	0.89	0.43	0.69	0.89	0.89	0.64
8500	0.58	0.79	0.79	0.79	0.35	0.56	0.77	0.79	0.53
9000	0.50	0.70	0.70	0.70	0.28	0.45	0.66	0.70	0.45
9500	0.43	0.63	0.63	0.63	0.23	0.37	0.56	0.63	0.38
10000	0.37	0.57	0.57	0.57	0.19	0.31	0.48	0.57	0.33

Z150-15									
Span	Inward				Outward				Def 'n L/150
	0	1	2	3	0	1	2	3	
2000	14.09	14.09	14.09	14.09	14.09	14.09	14.08	14.09	51.63
2500	10.06	10.06	10.06	10.06	10.06	10.06	10.06	10.06	26.44
3000	7.43	7.51	7.51	7.51	7.51	7.51	7.51	7.51	15.30
3500	5.30	5.79	5.79	5.79	5.79	5.79	5.79	5.79	9.63
4000	3.96	4.54	4.54	4.54	4.42	4.54	4.54	4.54	6.45
4500	3.07	3.58	3.58	3.58	3.31	3.58	3.59	3.59	4.53
5000	2.44	2.90	2.90	2.90	2.53	2.90	2.90	2.90	3.31
5500	1.98	2.40	2.40	2.40	1.98	2.37	2.40	2.40	2.48
6000	1.63	2.02	2.02	2.02	1.54	1.92	2.02	2.02	1.91
6500	1.36	1.72	1.72	1.72	1.18	1.56	1.72	1.72	1.50
7000	1.14	1.48	1.48	1.48	0.90	1.29	1.48	1.48	1.20
7500	0.96	1.29	1.29	1.29	0.70	1.07	1.27	1.29	0.98
8000	0.82	1.13	1.13	1.13	0.55	0.90	1.08	1.13	0.81
8500	0.70	1.01	1.01	1.01	0.44	0.74	0.93	1.01	0.67
9000	0.60	0.89	0.90	0.90	0.36	0.60	0.80	0.90	0.57
9500	0.52	0.79	0.80	0.80	0.30	0.49	0.69	0.79	0.48
10000	0.45	0.70	0.73	0.73	0.25	0.40	0.61	0.70	0.41

Z150-19									
Span	Inward				Outward				Def 'n L/150
	0	1	2	3	0	1	2	3	
2000	22.79	22.79	22.79	22.79	22.78	22.79	22.79	22.79	66.20
2500	14.73	15.57	15.57	15.57	15.57	15.57	15.57	15.57	33.89
3000	9.70	11.19	11.19	11.19	11.19	11.19	11.19	11.19	19.61
3500	6.81	8.22	8.22	8.22	8.22	8.22	8.22	8.22	12.35
4000	5.01	6.29	6.29	6.29	6.09	6.29	6.29	6.29	8.28
4500	3.81	4.97	4.97	4.97	4.54	4.97	4.97	4.97	5.81
5000	2.98	4.03	4.03	4.03	3.42	4.03	4.03	4.03	4.24
5500	2.38	3.33	3.33	3.33	2.60	3.27	3.33	3.33	3.18
6000	1.94	2.80	2.80	2.80	1.99	2.65	2.80	2.80	2.45
6500	1.60	2.38	2.38	2.38	1.53	2.15	2.38	2.38	1.93
7000	1.33	2.06	2.06	2.06	1.17	1.75	2.05	2.06	1.54
7500	1.12	1.79	1.79	1.79	0.92	1.44	1.75	1.79	1.26
8000	0.95	1.57	1.57	1.57	0.73	1.18	1.50	1.57	1.03
8500	0.81	1.38	1.39	1.39	0.59	0.97	1.28	1.39	0.86
9000	0.70	1.21	1.24	1.24	0.49	0.79	1.10	1.23	0.73
9500	0.61	1.08	1.12	1.12	0.40	0.65	0.94	1.09	0.62
10000	0.53	0.96	1.01	1.01	0.34	0.54	0.81	0.97	0.53

Z150-24									
Span	Inward				Outward				Def 'n L/150
	0	1	2	3	0	1	2	3	
2000	24.62	24.62	24.62	24.62	24.62	24.62	24.62	24.62	83.94
2500	17.86	19.70	19.70	19.70	19.70	19.70	19.70	19.70	42.98
3000	11.64	15.20	15.20	15.20	15.06	15.20	15.20	15.20	24.87
3500	8.10	11.17	11.17	11.17	10.55	11.17	11.17	11.17	15.66
4000	5.92	8.55	8.55	8.55	7.65	8.55	8.55	8.55	10.49
4500	4.49	6.75	6.75	6.75	5.69	6.66	6.75	6.75	7.37
5000	3.50	5.45	5.47	5.47	4.30	5.22	5.47	5.47	5.37
5500	2.79	4.45	4.52	4.52	3.30	4.15	4.52	4.52	4.04
6000	2.26	3.69	3.80	3.80	2.55	3.34	3.76	3.80	3.11
6500	1.87	3.11	3.24	3.24	1.98	2.72	3.13	3.24	2.45
7000	1.56	2.65	2.79	2.79	1.54	2.23	2.63	2.79	1.96
7500	1.32	2.28	2.43	2.43	1.22	1.84	2.22	2.42	1.59
8000	1.12	1.98	2.14	2.14	0.98	1.52	1.89	2.08	1.31
8500	0.97	1.73	1.89	1.89	0.80	1.26	1.62	1.81	1.09
9000	0.84	1.52	1.67	1.69	0.66	1.04	1.39	1.58	0.92
9500	0.73	1.34	1.48	1.52	0.55	0.87	1.20	1.38	0.78
10000	0.64	1.19	1.32	1.37	0.47	0.72	1.04	1.22	0.67

**NOTE:**

Bolting of section sizes from 100 to 250mm inclusive requires M12 grade 4.6 bolts.

300mm and 350mm sections require M16 grade 4.6 bolts.

Shaded values require grade 8.8 bolts.



# DESIGN CAPACITY TABLES

Two lapped spans are continuous over two bays, supported at each end of the purlin and lapped over one internal support.

(Tables in kN/m)

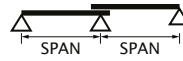

# 2 LAPPED

Z200-12									
Span	Inward				Outward				Def 'n L/150
	0	1	2	3	0	1	2	3	
2000	6.81	6.81	6.81	6.81	6.81	6.81	6.81	6.81	85.01
2500	5.33	5.33	5.33	5.33	5.33	5.33	5.33	5.33	43.53
3000	4.32	4.32	4.32	4.32	4.32	4.32	4.32	4.32	25.19
3500	3.59	3.59	3.59	3.59	3.59	3.59	3.59	3.59	15.86
4000	3.04	3.04	3.04	3.04	3.04	3.04	3.04	3.04	10.63
4500	2.61	2.61	2.61	2.61	2.61	2.61	2.61	2.61	7.46
5000	2.27	2.27	2.27	2.27	2.27	2.27	2.27	2.27	5.44
5500	1.99	1.99	1.99	1.99	1.99	1.99	1.99	1.99	4.09
6000	1.75	1.75	1.75	1.75	1.75	1.75	1.75	1.75	3.15
6500	1.56	1.56	1.56	1.56	1.56	1.56	1.56	1.56	2.48
7000	1.36	1.39	1.39	1.39	1.29	1.39	1.39	1.39	1.98
7500	1.16	1.25	1.25	1.25	1.05	1.25	1.25	1.25	1.61
8000	1.00	1.13	1.13	1.13	0.83	1.13	1.13	1.13	1.33
8500	0.87	1.02	1.02	1.02	0.67	0.97	1.02	1.02	1.11
9000	0.76	0.93	0.93	0.93	0.55	0.83	0.93	0.93	0.93
9500	0.66	0.85	0.85	0.85	0.45	0.71	0.85	0.85	0.79
10000	0.58	0.78	0.78	0.78	0.38	0.60	0.76	0.78	0.68

Z200-15									
Span	Inward				Outward				Def 'n L/150
	0	1	2	3	0	1	2	3	
2000	12.72	12.73	12.73	12.73	12.72	12.73	12.73	12.73	110.82
2500	9.73	9.73	9.73	9.73	9.73	9.73	9.73	9.73	56.74
3000	7.71	7.71	7.71	7.71	7.71	7.71	7.71	7.71	32.84
3500	6.26	6.26	6.26	6.26	6.26	6.26	6.26	6.26	20.68
4000	5.19	5.19	5.19	5.19	5.19	5.19	5.19	5.19	13.85
4500	4.36	4.36	4.36	4.36	4.36	4.36	4.36	4.36	9.73
5000	3.60	3.71	3.71	3.71	3.71	3.71	3.71	3.71	7.09
5500	2.89	3.19	3.19	3.19	3.19	3.19	3.19	3.19	5.33
6000	2.36	2.77	2.77	2.77	2.67	2.77	2.77	2.77	4.11
6500	1.96	2.42	2.42	2.42	2.12	2.42	2.42	2.42	3.23
7000	1.64	2.14	2.14	2.14	1.69	2.14	2.14	2.14	2.59
7500	1.39	1.86	1.86	1.86	1.34	1.84	1.86	1.86	2.10
8000	1.19	1.64	1.64	1.64	1.07	1.56	1.64	1.64	1.73
8500	1.02	1.45	1.45	1.45	0.89	1.31	1.45	1.45	1.44
9000	0.88	1.29	1.29	1.29	0.73	1.11	1.29	1.29	1.22
9500	0.77	1.16	1.16	1.16	0.59	0.94	1.16	1.16	1.03
10000	0.68	1.05	1.05	1.05	0.49	0.79	1.04	1.05	0.89

Z200-19									
Span	Inward				Outward				Def 'n L/150
	0	1	2	3	0	1	2	3	
2500	17.74	17.74	17.74	17.74	17.74	17.74	17.74	17.74	74.56
3000	13.65	13.65	13.65	13.65	13.65	13.65	13.65	13.65	43.15
3500	10.55	10.80	10.80	10.80	10.80	10.80	10.80	10.80	27.17
4000	7.78	8.73	8.73	8.73	8.73	8.73	8.73	8.73	18.20
4500	5.95	7.18	7.18	7.18	7.18	7.18	7.18	7.18	12.78
5000	4.64	6.01	6.01	6.01	5.79	6.01	6.01	6.01	9.32
5500	3.67	5.02	5.02	5.02	4.55	5.02	5.02	5.02	7.00
6000	2.95	4.22	4.22	4.22	3.65	4.22	4.22	4.22	5.39
6500	2.41	3.59	3.59	3.59	2.96	3.58	3.59	3.59	4.24
7000	2.00	3.10	3.10	3.10	2.41	2.99	3.10	3.10	3.40
7500	1.68	2.70	2.70	2.70	1.90	2.51	2.70	2.70	2.76
8000	1.43	2.37	2.37	2.37	1.50	2.13	2.37	2.37	2.28
8500	1.23	2.10	2.10	2.10	1.20	1.82	2.10	2.10	1.90
9000	1.06	1.87	1.87	1.87	0.97	1.56	1.85	1.87	1.60
9500	0.93	1.68	1.68	1.68	0.80	1.34	1.62	1.68	1.36
10000	0.81	1.50	1.52	1.52	0.66	1.15	1.42	1.52	1.17
10500	0.72	1.34	1.38	1.38	0.56	0.96	1.25	1.38	1.01
11000	0.64	1.20	1.26	1.26	0.47	0.80	1.11	1.26	0.88
11500	0.57	1.09	1.15	1.15	0.40	0.68	0.99	1.13	0.77
12000	0.51	0.98	1.05	1.05	0.35	0.58	0.88	1.01	0.67

Z200-24									
Span	Inward				Outward				Def 'n L/150
	0	1	2	3	0	1	2	3	
2500	19.70	19.70	19.70	19.70	19.70	19.70	19.70	19.70	95.27
3000	16.42	16.42	16.42	16.42	16.42	16.42	16.42	16.42	55.14
3500	13.15	14.07	14.07	14.07	14.07	14.07	14.07	14.07	34.72
4000	9.37	12.31	12.31	12.31	12.31	12.31	12.31	12.31	23.26
4500	6.93	10.36	10.36	10.36	10.19	10.36	10.36	10.36	16.34
5000	5.28	8.39	8.39	8.39	7.91	8.39	8.39	8.39	11.91
5500	4.13	6.93	6.93	6.93	6.20	6.93	6.93	6.93	8.95
6000	3.32	5.83	5.83	5.83	4.87	5.83	5.83	5.83	6.89
6500	2.71	4.96	4.96	4.96	3.85	4.90	4.96	4.96	5.42
7000	2.26	4.28	4.28	4.28	3.05	4.10	4.28	4.28	4.34
7500	1.90	3.73	3.73	3.73	2.42	3.45	3.73	3.73	3.53
8000	1.62	3.26	3.28	3.28	1.92	2.91	3.28	3.28	2.91
8500	1.40	2.87	2.90	2.90	1.54	2.45	2.90	2.90	2.42
9000	1.21	2.53	2.59	2.59	1.26	2.07	2.53	2.59	2.04
9500	1.06	2.25	2.32	2.32	1.04	1.75	2.22	2.32	1.74
10000	0.94	2.01	2.10	2.10	0.87	1.48	1.95	2.10	1.49
10500	0.83	1.80	1.90	1.90	0.73	1.24	1.72	1.90	1.29
11000	0.74	1.62	1.73	1.73	0.62	1.05	1.51	1.72	1.12
11500	0.66	1.46	1.59	1.59	0.53	0.89	1.33	1.54	0.98
12000	0.59	1.32	1.46	1.46	0.46	0.76	1.17	1.39	0.86

**NOTE:** Bolting of section sizes from 100 to 250mm inclusive requires M12 grade 4.6 bolts. 300mm and 350mm sections require M16 grade 4.6 bolts. Shaded values require grade 8.8 bolts.

# 2 LAPPED

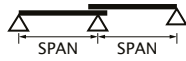

# DESIGN CAPACITY TABLES

Two lapped spans are continuous over two bays, supported at each end of the purlin and lapped over one internal support.

(Tables in kN/m)

Z250-15									
Span	Inward				Outward				Def 'n L/150
	0	1	2	3	0	1	2	3	
2000	10.59	10.59	10.59	10.59	10.59	10.59	10.59	10.59	185.75
2500	8.30	8.30	8.30	8.30	8.30	8.30	8.30	8.30	95.10
3000	6.75	6.75	6.75	6.75	6.75	6.75	6.75	6.75	55.04
3500	5.63	5.63	5.63	5.63	5.63	5.63	5.63	5.63	34.66
4000	4.79	4.79	4.79	4.79	4.79	4.79	4.79	4.79	23.22
4500	4.12	4.12	4.12	4.12	4.12	4.12	4.12	4.12	16.31
5000	3.59	3.59	3.59	3.59	3.59	3.59	3.59	3.59	11.89
5500	3.15	3.15	3.15	3.15	3.15	3.15	3.15	3.15	8.93
6000	2.79	2.79	2.79	2.79	2.79	2.79	2.79	2.79	6.88
6500	2.49	2.49	2.49	2.49	2.49	2.49	2.49	2.49	5.41
7000	2.12	2.23	2.23	2.23	2.23	2.23	2.23	2.23	4.33
7500	1.79	2.01	2.01	2.01	1.84	2.01	2.01	2.01	3.52
8000	1.53	1.82	1.82	1.82	1.47	1.82	1.82	1.82	2.90
8500	1.31	1.65	1.65	1.65	1.19	1.65	1.65	1.65	2.42
9000	1.14	1.51	1.51	1.51	0.99	1.44	1.51	1.51	2.04
9500	0.99	1.38	1.38	1.38	0.81	1.24	1.38	1.38	1.73
10000	0.87	1.27	1.27	1.27	0.67	1.07	1.27	1.27	1.49
10500	0.78	1.17	1.17	1.17	0.56	0.92	1.15	1.17	1.28
11000	0.69	1.08	1.08	1.08	0.47	0.78	1.02	1.08	1.12
11500	0.62	1.00	1.00	1.00	0.40	0.66	0.91	1.00	0.98
12000	0.56	0.91	0.93	0.93	0.34	0.57	0.82	0.92	0.86

Z250-19									
Span	Inward				Outward				Def 'n L/150
	0	1	2	3	0	1	2	3	
2000	20.84	20.84	20.84	20.84	20.84	20.84	20.84	20.84	243.04
2500	16.06	16.06	16.06	16.06	16.06	16.06	16.06	16.06	124.44
3000	12.83	12.83	12.83	12.83	12.83	12.83	12.83	12.83	72.01
3500	10.50	10.50	10.50	10.50	10.50	10.50	10.50	10.50	45.35
4000	8.76	8.76	8.76	8.76	8.76	8.76	8.76	8.76	30.38
4500	7.39	7.41	7.41	7.41	7.41	7.41	7.41	7.41	21.34
5000	5.75	6.34	6.34	6.34	6.34	6.34	6.34	6.34	15.56
5500	4.55	5.48	5.48	5.48	5.48	5.48	5.48	5.48	11.69
6000	3.67	4.78	4.78	4.78	4.76	4.78	4.78	4.78	9.00
6500	3.00	4.20	4.20	4.20	3.82	4.20	4.20	4.20	7.08
7000	2.49	3.72	3.72	3.72	3.08	3.72	3.72	3.72	5.67
7500	2.10	3.31	3.31	3.31	2.47	3.31	3.31	3.31	4.61
8000	1.78	2.96	2.96	2.96	1.97	2.80	2.96	2.96	3.80
8500	1.53	2.62	2.62	2.62	1.57	2.37	2.62	2.62	3.17
9000	1.32	2.34	2.34	2.34	1.27	2.02	2.34	2.34	2.67
9500	1.15	2.10	2.10	2.10	1.04	1.72	2.10	2.10	2.27
10000	1.01	1.90	1.90	1.90	0.86	1.47	1.88	1.90	1.94
10500	0.89	1.72	1.72	1.72	0.72	1.25	1.65	1.72	1.68
11000	0.79	1.57	1.57	1.57	0.61	1.05	1.46	1.57	1.46
11500	0.71	1.43	1.43	1.43	0.51	0.89	1.29	1.43	1.28
12000	0.63	1.29	1.32	1.32	0.44	0.75	1.14	1.32	1.13

Z250-24									
Span	Inward				Outward				Def 'n L/150
	0	1	2	3	0	1	2	3	
3000	16.42	16.42	16.42	16.42	16.42	16.42	16.42	16.42	93.25
3500	14.07	14.07	14.07	14.07	14.07	14.07	14.07	14.07	58.72
4000	11.83	12.31	12.31	12.31	12.31	12.31	12.31	12.31	39.34
4500	8.62	10.94	10.94	10.94	10.94	10.94	10.94	10.94	27.63
5000	6.52	9.85	9.85	9.85	9.85	9.85	9.85	9.85	20.14
5500	5.09	8.75	8.75	8.75	8.14	8.75	8.75	8.75	15.13
6000	4.08	7.35	7.35	7.35	6.44	7.35	7.35	7.35	11.66
6500	3.33	6.27	6.27	6.27	5.13	6.27	6.27	6.27	9.17
7000	2.77	5.40	5.40	5.40	4.04	5.36	5.40	5.40	7.34
7500	2.33	4.71	4.71	4.71	3.16	4.52	4.71	4.71	5.96
8000	1.99	4.14	4.14	4.14	2.49	3.81	4.14	4.14	4.91
8500	1.71	3.66	3.66	3.66	2.00	3.22	3.66	3.66	4.10
9000	1.48	3.27	3.27	3.27	1.62	2.74	3.27	3.27	3.45
9500	1.30	2.91	2.93	2.93	1.33	2.32	2.90	2.93	2.94
10000	1.14	2.60	2.65	2.65	1.11	1.94	2.56	2.65	2.52
10500	1.01	2.33	2.40	2.40	0.93	1.62	2.25	2.40	2.17
11000	0.90	2.10	2.19	2.19	0.79	1.36	1.98	2.19	1.89
11500	0.81	1.89	2.00	2.00	0.67	1.15	1.75	2.00	1.65
12000	0.72	1.71	1.84	1.84	0.58	0.98	1.55	1.82	1.46
12500	0.65	1.55	1.69	1.69	0.50	0.84	1.37	1.65	1.29
13000	0.59	1.41	1.57	1.57	0.44	0.72	1.20	1.49	1.15
13500	0.54	1.28	1.45	1.45	0.38	0.63	1.05	1.34	1.02
14000	0.49	1.17	1.35	1.35	0.34	0.55	0.92	1.22	0.92
14500	0.44	1.07	1.25	1.26	0.30	0.48	0.80	1.10	0.83
15000	0.41	0.98	1.15	1.18	0.27	0.42	0.71	1.00	0.75

**NOTE:** Bolting of section sizes from 100 to 250mm inclusive requires M12 grade 4.6 bolts. 300mm and 350mm sections require M16 grade 4.6 bolts. Shaded values require grade 8.8 bolts.

# DESIGN CAPACITY TABLES

**Two lapped spans** are continuous over two bays, supported at each end of the purlin and lapped over one internal support.

(Tables in kN/m)



# 2 LAPPED

Z300-19									
Span	Inward				Outward				Def 'n L/150
	0	1	2	3	0	1	2	3	
3000	11.56	11.56	11.56	11.56	11.56	11.56	11.56	11.56	125.97
3500	9.69	9.69	9.69	9.69	9.69	9.69	9.69	9.69	79.33
4000	8.27	8.27	8.27	8.27	8.27	8.27	8.27	8.27	53.14
4500	7.16	7.16	7.16	7.16	7.16	7.16	7.16	7.16	37.33
5000	6.27	6.27	6.27	6.27	6.27	6.27	6.27	6.27	27.21
5500	5.54	5.54	5.54	5.54	5.54	5.54	5.54	5.54	20.44
6000	4.93	4.93	4.93	4.93	4.93	4.93	4.93	4.93	15.75
6500	4.15	4.41	4.41	4.41	4.41	4.41	4.41	4.41	12.38
7000	3.44	3.97	3.97	3.97	3.97	3.97	3.97	3.97	9.92
7500	2.90	3.59	3.59	3.59	3.59	3.59	3.59	3.59	8.06
8000	2.47	3.26	3.26	3.26	3.26	3.26	3.26	3.26	6.64
8500	2.13	2.97	2.97	2.97	2.97	2.97	2.97	2.97	5.54
9000	1.86	2.72	2.72	2.72	2.57	2.72	2.72	2.72	4.67
9500	1.64	2.50	2.50	2.50	2.15	2.50	2.50	2.50	3.97
10000	1.45	2.30	2.30	2.30	1.80	2.30	2.30	2.30	3.40
10500	1.29	2.13	2.13	2.13	1.52	2.13	2.13	2.13	2.94
11000	1.15	1.97	1.97	1.97	1.29	1.91	1.97	1.97	2.56
11500	1.03	1.83	1.83	1.83	1.12	1.69	1.83	1.83	2.24
12000	0.92	1.70	1.70	1.70	0.97	1.51	1.70	1.70	1.97
12500	0.83	1.59	1.59	1.59	0.83	1.35	1.59	1.59	1.74
13000	0.75	1.48	1.48	1.48	0.72	1.19	1.46	1.48	1.55
13500	0.68	1.36	1.39	1.39	0.62	1.04	1.33	1.39	1.38
14000	0.62	1.25	1.30	1.30	0.54	0.91	1.21	1.30	1.24
14500	0.57	1.16	1.22	1.22	0.48	0.81	1.11	1.22	1.12
15000	0.52	1.07	1.14	1.14	0.42	0.71	1.02	1.13	1.01
15500	0.48	1.00	1.06	1.06	0.37	0.64	0.93	1.05	0.91
16000	0.44	0.93	1.00	1.00	0.33	0.57	0.85	0.97	0.83
16500	0.41	0.86	0.94	0.94	0.30	0.51	0.78	0.90	0.76
17000	0.38	0.81	0.88	0.88	0.27	0.46	0.72	0.84	0.69
17500	0.35	0.75	0.83	0.83	0.24	0.41	0.65	0.78	0.64
18000	0.32	0.70	0.78	0.79	0.22	0.37	0.59	0.73	0.58

Z300-24									
Span	Inward				Outward				Def 'n L/150
	0	1	2	3	0	1	2	3	
3000	22.08	22.08	22.08	22.08	22.08	22.08	22.08	22.08	164.27
3500	18.22	18.22	18.22	18.22	18.22	18.22	18.22	18.22	103.44
4000	15.30	15.31	15.31	15.31	15.31	15.31	15.31	15.31	69.30
4500	13.04	13.04	13.04	13.04	13.04	13.04	13.04	13.04	48.67
5000	9.96	11.24	11.24	11.24	11.24	11.24	11.23	11.24	35.48
5500	7.70	9.77	9.77	9.77	9.77	9.77	9.77	9.77	26.66
6000	6.08	8.57	8.57	8.57	8.57	8.57	8.57	8.57	20.53
6500	4.89	7.57	7.57	7.57	7.57	7.57	7.57	7.57	16.15
7000	4.02	6.73	6.73	6.73	6.73	6.73	6.73	6.73	12.93
7500	3.35	6.02	6.02	6.02	5.74	6.02	6.02	6.02	10.51
8000	2.84	5.41	5.41	5.41	4.77	5.41	5.41	5.41	8.66
8500	2.43	4.89	4.89	4.89	3.99	4.89	4.89	4.89	7.22
9000	2.10	4.43	4.43	4.43	3.36	4.43	4.43	4.43	6.08
9500	1.83	3.98	3.98	3.98	2.84	3.91	3.98	3.98	5.17
10000	1.61	3.59	3.59	3.59	2.39	3.41	3.59	3.59	4.44
10500	1.43	3.26	3.26	3.26	2.01	2.99	3.26	3.26	3.83
11000	1.27	2.97	2.97	2.97	1.69	2.62	2.97	2.97	3.33
11500	1.14	2.69	2.71	2.71	1.43	2.30	2.71	2.71	2.92
12000	1.02	2.45	2.49	2.49	1.23	2.02	2.49	2.49	2.57
12500	0.93	2.23	2.30	2.30	1.06	1.79	2.29	2.30	2.27
13000	0.84	2.04	2.12	2.12	0.91	1.58	2.07	2.12	2.02
13500	0.76	1.87	1.97	1.97	0.80	1.40	1.87	1.97	1.80
14000	0.70	1.72	1.83	1.83	0.70	1.23	1.70	1.83	1.62
14500	0.64	1.58	1.71	1.71	0.61	1.09	1.54	1.71	1.46
15000	0.59	1.46	1.60	1.60	0.54	0.96	1.39	1.60	1.31
15500	0.54	1.35	1.49	1.49	0.48	0.84	1.27	1.49	1.19
16000	0.50	1.25	1.40	1.40	0.43	0.75	1.15	1.39	1.08
16500	0.46	1.16	1.32	1.32	0.39	0.66	1.05	1.28	0.99
17000	0.43	1.07	1.24	1.24	0.35	0.59	0.96	1.18	0.90
17500	0.40	1.00	1.17	1.17	0.31	0.53	0.87	1.09	0.83
18000	0.37	0.93	1.11	1.11	0.28	0.48	0.79	1.01	0.76

Z300-30									
Span	Inward				Outward				Def 'n L/150
	0	1	2	3	0	1	2	3	
4000	23.27	23.27	23.27	23.27	23.27	23.27	23.27	23.27	89.56
4500	16.46	20.68	20.68	20.68	20.68	20.68	20.68	20.68	62.90
5000	11.99	18.35	18.35	18.35	18.35	18.35	18.35	18.35	45.85
5500	9.07	15.71	15.71	15.71	15.71	15.71	15.71	15.71	34.45
6000	7.09	13.58	13.58	13.58	13.58	13.58	13.58	13.58	26.54
6500	5.67	11.84	11.84	11.84	11.54	11.84	11.84	11.84	20.87
7000	4.64	10.41	10.41	10.41	9.62	10.41	10.41	10.41	16.71
7500	3.86	9.08	9.08	9.08	8.02	9.08	9.08	9.08	13.59
8000	3.26	7.98	7.98	7.98	6.70	7.98	7.98	7.98	11.19
8500	2.79	7.03	7.07	7.07	5.56	7.05	7.07	7.07	9.33
9000	2.41	6.20	6.31	6.31	4.60	6.16	6.31	6.31	7.86
9500	2.10	5.50	5.66	5.66	3.79	5.41	5.66	5.66	6.69
10000	1.85	4.91	5.11	5.11	3.14	4.77	5.11	5.11	5.73
10500	1.63	4.41	4.63	4.63	2.62	4.21	4.63	4.63	4.95
11000	1.46	3.98	4.22	4.22	2.21	3.71	4.22	4.22	4.31
11500	1.31	3.60	3.86	3.86	1.88	3.27	3.85	3.86	3.77
12000	1.18	3.28	3.55	3.55	1.61	2.88	3.49	3.55	3.32
12500	1.06	2.99	3.27	3.27	1.39	2.51	3.16	3.27	2.93
13000	0.97	2.73	3.02	3.02	1.21	2.19	2.87	3.02	2.61
13500	0.88	2.50	2.80	2.80	1.06	1.91	2.62	2.80	2.33
14000	0.81	2.30	2.61	2.61	0.93	1.67	2.39	2.61	2.09
14500	0.74	2.12	2.43	2.43	0.82	1.46	2.17	2.43	1.88
15000	0.68	1.96	2.26	2.27	0.73	1.28	1.98	2.24	1.70
15500	0.63	1.81	2.11	2.13	0.65	1.13	1.80	2.07	1.54
16000	0.58	1.68	1.97	2.00	0.58	1.00	1.64	1.92	1.40
16500	0.54	1.56	1.84	1.88	0.52	0.89	1.48	1.78	1.28
17000	0.50	1.44	1.72	1.77	0.47	0.80	1.34	1.65	1.17
17500	0.47	1.34	1.62	1.67	0.42	0.72	1.21	1.54	1.07
18000	0.44	1.24	1.52	1.58	0.39	0.65	1.09	1.43	0.98

**NOTE:**

Bolting of section sizes from 100 to 250mm inclusive requires M12 grade 4.6 bolts.  
300mm and 350mm sections require M16 grade 4.6 bolts.  
Shaded values require grade 8.8 bolts.

# 2 LAPPED

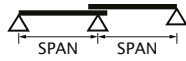

## DESIGN CAPACITY TABLES

Two lapped spans are continuous over two bays, supported at each end of the purlin and lapped over one internal support.

(Tables in kN/m)

Span	Inward				Outward				Def 'n L/150
	0	1	2	3	0	1	2	3	
3000	10.20	10.20	10.20	10.20	10.20	10.20	10.20	10.20	205.47
3500	8.65	8.65	8.65	8.65	8.65	8.65	8.65	8.65	129.39
4000	7.48	7.48	7.48	7.47	7.48	7.48	7.48	7.48	86.68
4500	6.56	6.56	6.56	6.56	6.56	6.56	6.56	6.56	60.88
5000	5.82	5.82	5.82	5.82	5.82	5.82	5.82	5.82	44.38
5500	5.21	5.21	5.21	5.21	5.21	5.21	5.21	5.21	33.34
6000	4.70	4.70	4.70	4.70	4.70	4.70	4.70	4.70	25.68
6500	4.26	4.26	4.26	4.26	4.26	4.26	4.26	4.26	20.20
7000	3.89	3.89	3.89	3.89	3.88	3.88	3.89	3.89	16.17
7500	3.56	3.56	3.56	3.56	3.56	3.56	3.56	3.56	13.15
8000	3.27	3.27	3.27	3.27	3.27	3.27	3.27	3.27	10.84
8500	2.91	3.02	3.02	3.02	3.02	3.02	3.02	3.02	9.03
9000	2.51	2.80	2.80	2.80	2.80	2.80	2.80	2.80	7.61
9500	2.19	2.59	2.59	2.59	2.59	2.59	2.59	2.59	6.47
10000	1.92	2.42	2.42	2.42	2.42	2.42	2.42	2.42	5.55
10500	1.70	2.25	2.25	2.25	2.25	2.25	2.25	2.25	4.79
11000	1.51	2.11	2.11	2.11	2.11	2.11	2.11	2.11	4.17
11500	1.36	1.97	1.97	1.97	1.97	1.97	1.97	1.97	3.65
12000	1.22	1.85	1.85	1.85	1.74	1.85	1.85	1.85	3.21
12500	1.10	1.74	1.74	1.74	1.53	1.74	1.74	1.74	2.84
13000	1.00	1.64	1.64	1.64	1.36	1.64	1.64	1.64	2.53
13500	0.91	1.54	1.54	1.54	1.21	1.54	1.54	1.54	2.26
14000	0.83	1.46	1.46	1.46	1.06	1.46	1.46	1.46	2.02
14500	0.77	1.38	1.38	1.38	0.94	1.37	1.38	1.38	1.82
15000	0.70	1.31	1.31	1.31	0.83	1.25	1.31	1.31	1.64
15500	0.65	1.24	1.24	1.24	0.74	1.14	1.24	1.24	1.49
16000	0.60	1.18	1.18	1.18	0.66	1.04	1.18	1.18	1.35
16500	0.56	1.12	1.12	1.12	0.60	0.95	1.12	1.12	1.24
17000	0.52	1.06	1.06	1.06	0.54	0.86	1.06	1.06	1.13
17500	0.48	1.00	1.01	1.01	0.48	0.79	1.00	1.01	1.04
18000	0.45	0.94	0.97	0.97	0.44	0.72	0.93	0.97	0.95

Span	Inward				Outward				Def 'n L/150
	0	1	2	3	0	1	2	3	
3000	20.04	20.04	20.04	20.04	20.04	20.04	20.04	20.04	267.96
3500	16.84	16.84	16.84	16.84	16.84	16.84	16.84	16.84	168.74
4000	14.41	14.41	14.41	14.41	14.41	14.41	14.41	14.41	113.05
4500	12.51	12.51	12.51	12.51	12.51	12.51	12.51	12.51	79.40
5000	10.98	10.98	10.98	10.98	10.98	10.98	10.98	10.98	57.88
5500	9.72	9.72	9.72	9.72	9.72	9.72	9.72	9.72	43.49
6000	8.67	8.67	8.67	8.67	8.67	8.67	8.67	8.67	33.49
6500	7.10	7.78	7.78	7.78	7.78	7.78	7.78	7.78	26.35
7000	5.79	7.01	7.02	7.02	7.02	7.02	7.02	7.02	21.09
7500	4.80	6.36	6.36	6.36	6.36	6.36	6.36	6.36	17.15
8000	4.05	5.79	5.79	5.79	5.79	5.79	5.79	5.79	14.13
8500	3.48	5.29	5.29	5.29	5.29	5.29	5.29	5.29	11.78
9000	3.00	4.85	4.85	4.85	4.85	4.85	4.85	4.85	9.92
9500	2.60	4.46	4.46	4.46	4.46	4.46	4.46	4.46	8.44
10000	2.27	4.12	4.12	4.12	4.12	4.12	4.12	4.12	7.24
10500	1.99	3.81	3.81	3.81	3.67	3.81	3.81	3.81	6.25
11000	1.77	3.53	3.53	3.53	3.18	3.53	3.53	3.53	5.44
11500	1.57	3.28	3.28	3.28	2.74	3.28	3.28	3.28	4.76
12000	1.41	3.06	3.06	3.06	2.37	3.06	3.06	3.06	4.19
12500	1.27	2.86	2.85	2.85	2.06	2.86	2.85	2.85	3.70
13000	1.15	2.67	2.67	2.67	1.80	2.61	2.67	2.67	3.29
13500	1.05	2.50	2.50	2.50	1.58	2.38	2.51	2.51	2.94
14000	0.96	2.31	2.35	2.35	1.40	2.17	2.35	2.35	2.64
14500	0.88	2.13	2.21	2.21	1.24	1.98	2.21	2.21	2.37
15000	0.80	1.98	2.09	2.09	1.11	1.80	2.09	2.09	2.14
15500	0.74	1.84	1.95	1.95	0.99	1.64	1.93	1.95	1.94
16000	0.69	1.72	1.83	1.83	0.88	1.47	1.79	1.83	1.77
16500	0.63	1.60	1.72	1.72	0.79	1.33	1.67	1.72	1.61
17000	0.59	1.50	1.63	1.63	0.70	1.19	1.55	1.63	1.47
17500	0.55	1.41	1.53	1.53	0.63	1.08	1.44	1.53	1.35
18000	0.51	1.32	1.45	1.45	0.57	0.97	1.35	1.45	1.24

Span	Inward				Outward				Def 'n L/150
	0	1	2	3	0	1	2	3	
4000	23.27	23.27	23.27	23.27	23.27	23.27	23.28	23.28	145.72
4500	20.68	20.68	20.68	20.68	20.68	20.68	20.68	20.69	102.34
5000	18.49	18.62	18.62	18.62	18.62	18.62	18.62	18.62	74.61
5500	14.13	16.92	16.92	16.92	16.92	16.92	16.92	16.92	56.05
6000	10.94	14.91	14.91	14.91	14.91	14.91	14.91	14.91	43.17
6500	8.63	13.21	13.21	13.21	13.21	13.21	13.21	13.21	33.96
7000	6.92	11.78	11.78	11.78	11.78	11.78	11.78	11.78	27.19
7500	5.65	10.56	10.56	10.56	10.56	10.56	10.56	10.57	22.11
8000	4.70	9.52	9.52	9.52	9.52	9.52	9.52	9.52	18.22
8500	3.96	8.62	8.62	8.62	8.47	8.62	8.62	8.62	15.19
9000	3.38	7.83	7.83	7.83	7.28	7.83	7.83	7.83	12.79
9500	2.92	7.15	7.15	7.15	6.27	7.15	7.15	7.15	10.88
10000	2.55	6.49	6.49	6.49	5.42	6.49	6.49	6.49	9.33
10500	2.24	5.89	5.89	5.89	4.68	5.89	5.89	5.89	8.06
11000	1.98	5.32	5.37	5.37	4.04	5.37	5.37	5.37	7.01
11500	1.76	4.80	4.91	4.91	3.52	4.84	4.91	4.91	6.13
12000	1.58	4.35	4.51	4.51	3.08	4.35	4.51	4.51	5.40
12500	1.43	3.96	4.15	4.15	2.69	3.91	4.15	4.15	4.78
13000	1.29	3.61	3.84	3.84	2.35	3.52	3.84	3.84	4.25
13500	1.17	3.31	3.56	3.56	2.07	3.17	3.56	3.56	3.79
14000	1.07	3.03	3.31	3.31	1.81	2.86	3.31	3.31	3.40
14500	0.98	2.79	3.09	3.09	1.59	2.58	3.09	3.09	3.06
15000	0.90	2.58	2.89	2.89	1.40	2.33	2.89	2.89	2.76
15500	0.83	2.38	2.70	2.70	1.24	2.10	2.67	2.70	2.50
16000	0.77	2.21	2.54	2.54	1.10	1.90	2.47	2.54	2.28
16500	0.71	2.05	2.38	2.38	0.99	1.72	2.28	2.38	2.08
17000	0.66	1.91	2.25	2.25	0.89	1.56	2.11	2.25	1.90
17500	0.62	1.78	2.12	2.12	0.80	1.42	1.95	2.12	1.74
18000	0.58	1.66	2.00	2.00	0.72	1.29	1.80	2.00	1.60

**NOTE:**

Bolting of section sizes from 100 to 250mm inclusive requires M12 grade 4.6 bolts.

300mm and 350mm sections require M16 grade 4.6 bolts.

Shaded values require grade 8.8 bolts.

# DESIGN CAPACITY TABLES

Three lapped spans are continuous over three bays, supported at each end of the purlin and lapped over two internal supports.

(Tables in kN/m)



# 3 LAPPED

Z150-10									
Span	Inward				Outward				Def 'n L/150
	0	1	2	3	0	1	2	3	
2000	5.67	5.67	5.67	5.67	5.67	5.67	5.67	5.67	24.21
2500	4.43	4.43	4.43	4.43	4.43	4.43	4.43	4.43	12.40
3000	3.60	3.60	3.60	3.60	3.60	3.60	3.60	3.60	7.18
3500	2.99	2.99	2.99	2.99	2.99	2.99	2.99	2.99	4.52
4000	2.54	2.54	2.54	2.54	2.54	2.54	2.54	2.54	3.03
4500	2.18	2.18	2.18	2.18	2.18	2.18	2.18	2.18	2.13
5000	1.89	1.89	1.89	1.89	1.51	1.89	1.89	1.89	1.55
5500	1.53	1.66	1.66	1.66	1.07	1.66	1.66	1.66	1.16
6000	1.25	1.47	1.47	1.46	0.78	1.30	1.47	1.46	0.90
6500	1.02	1.30	1.30	1.30	0.59	1.01	1.28	1.30	0.71
7000	0.83	1.13	1.13	1.13	0.45	0.77	1.06	1.13	0.57
7500	0.68	0.98	0.98	0.98	0.35	0.60	0.88	0.98	0.46
8000	0.56	0.86	0.86	0.86	0.28	0.47	0.73	0.86	0.38
8500	0.47	0.77	0.77	0.77	0.22	0.38	0.61	0.74	0.32
9000	0.39	0.68	0.68	0.68	0.18	0.31	0.50	0.63	0.27

Z150-12									
Span	Inward				Outward				Def 'n L/150
	0	1	2	3	0	1	2	3	
2000	9.46	9.46	9.46	9.46	9.46	9.46	9.46	9.46	30.10
2500	7.27	7.27	7.27	7.27	7.27	7.27	7.27	7.27	15.41
3000	5.80	5.80	5.80	5.80	5.80	5.80	5.80	5.80	8.92
3500	4.73	4.73	4.73	4.73	4.73	4.73	4.73	4.73	5.62
4000	3.85	3.94	3.94	3.94	3.94	3.94	3.94	3.94	3.76
4500	2.94	3.32	3.32	3.32	2.76	3.32	3.32	3.32	2.64
5000	2.30	2.73	2.73	2.73	1.92	2.73	2.73	2.73	1.93
5500	1.83	2.26	2.26	2.26	1.36	2.14	2.26	2.26	1.45
6000	1.47	1.90	1.90	1.90	1.00	1.66	1.90	1.90	1.12
6500	1.20	1.62	1.62	1.62	0.75	1.29	1.62	1.62	0.88
7000	0.98	1.39	1.39	1.39	0.56	0.99	1.37	1.39	0.70
7500	0.81	1.22	1.22	1.22	0.43	0.77	1.13	1.22	0.57
8000	0.67	1.07	1.07	1.07	0.34	0.61	0.94	1.07	0.47
8500	0.57	0.95	0.95	0.95	0.27	0.49	0.78	0.95	0.39
9000	0.48	0.84	0.84	0.84	0.22	0.39	0.64	0.82	0.33

Z150-15									
Span	Inward				Outward				Def 'n L/150
	0	1	2	3	0	1	2	3	
2500	12.29	12.29	12.29	12.29	12.29	12.29	12.29	12.29	19.57
3000	8.44	9.42	9.42	9.42	9.42	9.42	9.42	9.42	11.33
3500	6.02	7.12	7.12	7.12	6.73	7.12	7.12	7.12	7.13
4000	4.49	5.45	5.45	5.45	4.77	5.45	5.45	5.45	4.78
4500	3.46	4.31	4.31	4.31	3.50	4.28	4.31	4.31	3.36
5000	2.71	3.49	3.49	3.49	2.51	3.31	3.49	3.49	2.45
5500	2.16	2.89	2.89	2.89	1.77	2.59	2.88	2.89	1.84
6000	1.75	2.42	2.42	2.42	1.27	2.06	2.41	2.42	1.42
6500	1.43	2.07	2.07	2.07	0.94	1.66	1.99	2.07	1.11
7000	1.17	1.78	1.78	1.78	0.72	1.30	1.65	1.78	0.89
7500	0.97	1.55	1.55	1.55	0.56	1.01	1.37	1.55	0.73
8000	0.81	1.36	1.36	1.36	0.44	0.79	1.16	1.33	0.60
8500	0.68	1.20	1.21	1.21	0.35	0.62	0.99	1.14	0.50
9000	0.58	1.06	1.08	1.08	0.29	0.50	0.83	0.99	0.42

Z150-19									
Span	Inward				Outward				Def 'n L/150
	0	1	2	3	0	1	2	3	
2500	16.49	19.37	19.37	19.37	19.40	19.40	19.40	19.40	25.09
3000	10.69	13.45	13.45	13.45	13.37	13.45	13.45	13.45	14.52
3500	7.40	9.88	9.88	9.88	9.26	9.88	9.88	9.88	9.15
4000	5.38	7.57	7.57	7.57	6.46	7.57	7.57	7.57	6.13
4500	4.05	5.98	5.98	5.98	4.56	5.89	5.98	5.98	4.30
5000	3.13	4.84	4.84	4.84	3.23	4.57	4.84	4.84	3.14
5500	2.48	4.00	4.00	4.00	2.28	3.55	4.00	4.00	2.36
6000	1.99	3.36	3.36	3.36	1.65	2.77	3.32	3.36	1.82
6500	1.63	2.87	2.87	2.87	1.23	2.17	2.75	2.87	1.43
7000	1.35	2.46	2.47	2.47	0.94	1.70	2.27	2.47	1.14
7500	1.13	2.13	2.15	2.15	0.74	1.32	1.88	2.13	0.93
8000	0.96	1.86	1.89	1.89	0.58	1.03	1.56	1.84	0.77
8500	0.81	1.63	1.68	1.68	0.47	0.82	1.30	1.58	0.64
9000	0.70	1.44	1.49	1.49	0.39	0.66	1.08	1.36	0.54

Z150-24									
Span	Inward				Outward				Def 'n L/150
	0	1	2	3	0	1	2	3	
2500	19.85	22.67	22.67	22.67	22.67	22.67	22.67	22.67	31.82
3000	12.69	18.27	18.27	18.27	17.03	18.27	18.27	18.27	18.42
3500	8.68	13.42	13.42	13.42	11.60	13.42	13.42	13.42	11.60
4000	6.25	10.19	10.28	10.28	8.13	9.92	10.28	10.28	7.77
4500	4.67	7.90	8.12	8.12	5.78	7.49	8.12	8.12	5.46
5000	3.60	6.30	6.58	6.58	4.13	5.75	6.50	6.58	3.98
5500	2.85	5.13	5.44	5.44	2.95	4.48	5.21	5.44	2.99
6000	2.31	4.25	4.57	4.57	2.16	3.52	4.23	4.57	2.30
6500	1.90	3.57	3.87	3.89	1.62	2.77	3.46	3.82	1.81
7000	1.59	3.05	3.30	3.36	1.25	2.19	2.86	3.21	1.45
7500	1.34	2.62	2.85	2.92	0.99	1.73	2.38	2.72	1.18
8000	1.15	2.28	2.48	2.57	0.79	1.36	1.98	2.32	0.97
8500	0.99	2.00	2.18	2.27	0.64	1.09	1.66	1.99	0.81
9000	0.85	1.77	1.93	2.01	0.53	0.88	1.39	1.72	0.68
9500	0.74	1.57	1.72	1.79	0.45	0.72	1.16	1.48	0.58
10000	0.65	1.40	1.54	1.61	0.38	0.60	0.97	1.28	0.50

**NOTE:** Bolting of section sizes from 100 to 250mm inclusive requires M12 grade 4.6 bolts. 300mm and 350mm sections require M16 grade 4.6 bolts. Shaded values require grade 8.8 bolts.

# 3 LAPPED

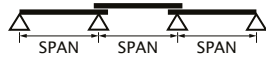

## DESIGN CAPACITY TABLES

Three lapped spans are continuous over three bays, supported at each end of the purlin and lapped over two internal supports.

(Tables in kN/m)

Z200-12									
Span	Inward				Outward				Def 'n L/150
	0	1	2	3	0	1	2	3	
2500	5.79	5.79	5.79	5.79	5.79	5.79	5.79	5.79	32.23
3000	4.75	4.75	4.75	4.75	4.75	4.75	4.75	4.75	18.65
3500	4.00	4.00	4.00	4.00	4.00	4.00	4.00	4.00	11.74
4000	3.43	3.43	3.43	3.43	3.43	3.43	3.43	3.43	7.87
4500	2.98	2.98	2.98	2.98	2.98	2.98	2.98	2.98	5.53
5000	2.62	2.62	2.62	2.62	2.62	2.62	2.62	2.62	4.03
5500	2.32	2.32	2.32	2.32	2.32	2.32	2.32	2.32	3.03
6000	2.07	2.07	2.07	2.07	1.97	2.07	2.07	2.07	2.33
6500	1.76	1.86	1.86	1.86	1.47	1.86	1.86	1.86	1.83
7000	1.48	1.68	1.68	1.68	1.13	1.68	1.68	1.68	1.47
7500	1.25	1.53	1.53	1.53	0.88	1.43	1.53	1.53	1.19
8000	1.06	1.39	1.39	1.39	0.70	1.18	1.39	1.39	0.98
8500	0.90	1.28	1.28	1.28	0.56	0.97	1.25	1.28	0.82
9000	0.77	1.17	1.17	1.17	0.45	0.79	1.08	1.17	0.69
9500	0.67	1.07	1.07	1.07	0.37	0.65	0.93	1.06	0.59
10000	0.58	0.96	0.96	0.96	0.30	0.54	0.81	0.93	0.50

Z200-15									
Span	Inward				Outward				Def 'n L/150
	0	1	2	3	0	1	2	3	
2500	10.88	10.88	10.88	10.88	10.88	10.88	10.88	10.88	42.01
3000	8.78	8.78	8.78	8.78	8.78	8.78	8.78	8.78	24.31
3500	7.27	7.27	7.27	7.27	7.27	7.27	7.27	7.27	15.31
4000	6.12	6.12	6.12	6.12	6.12	6.12	6.12	6.12	10.26
4500	4.98	5.23	5.23	5.23	5.23	5.23	5.23	5.23	7.20
5000	3.88	4.52	4.52	4.52	4.51	4.52	4.52	4.52	5.25
5500	3.08	3.94	3.94	3.94	3.38	3.94	3.94	3.94	3.95
6000	2.49	3.47	3.47	3.47	2.52	3.47	3.47	3.47	3.04
6500	2.05	2.98	2.98	2.98	1.91	2.87	2.98	2.98	2.39
7000	1.71	2.57	2.57	2.57	1.50	2.34	2.57	2.57	1.91
7500	1.44	2.24	2.24	2.24	1.15	1.91	2.24	2.24	1.56
8000	1.24	1.97	1.97	1.97	0.90	1.55	1.97	1.97	1.28
8500	1.07	1.74	1.74	1.74	0.72	1.26	1.71	1.74	1.07
9000	0.93	1.55	1.55	1.55	0.58	1.03	1.46	1.55	0.90
9500	0.81	1.40	1.40	1.40	0.47	0.86	1.25	1.40	0.77
10000	0.70	1.26	1.26	1.26	0.39	0.71	1.08	1.26	0.66

Z200-19									
Span	Inward				Outward				Def 'n L/150
	0	1	2	3	0	1	2	3	
3000	16.28	16.28	16.28	16.28	16.28	16.28	16.28	16.28	31.94
3500	11.81	13.17	13.17	13.17	13.17	13.17	13.17	13.17	20.12
4000	8.44	10.86	10.86	10.86	10.86	10.86	10.86	10.86	13.48
4500	6.21	9.01	9.01	9.01	8.17	9.01	9.01	9.01	9.47
5000	4.73	7.30	7.30	7.30	6.23	7.30	7.30	7.30	5.46
5500	3.71	6.03	6.03	6.03	4.80	5.98	6.03	6.03	4.97
6000	2.98	5.07	5.07	5.07	3.58	4.82	5.07	5.07	4.55
6500	2.44	4.32	4.32	4.32	2.64	3.92	4.32	4.32	4.20
7000	2.02	3.73	3.73	3.73	2.00	3.24	3.72	3.73	3.90
7500	1.70	3.24	3.24	3.25	1.54	2.69	3.19	3.25	3.64
8000	1.45	2.82	2.85	2.85	1.21	2.24	2.72	2.85	3.41
8500	1.24	2.48	2.53	2.53	0.97	1.81	2.33	2.53	3.21
9000	1.07	2.19	2.25	2.25	0.78	1.46	2.01	2.25	3.04
9500	0.93	1.95	2.02	2.02	0.64	1.18	1.74	1.99	2.87
10000	0.82	1.74	1.83	1.83	0.53	0.97	1.52	1.75	2.73
10500	0.72	1.57	1.66	1.66	0.44	0.80	1.32	1.55	2.60
11000	0.64	1.41	1.51	1.51	0.38	0.67	1.14	1.37	2.48
11500	0.56	1.28	1.38	1.38	0.32	0.57	0.97	1.22	2.38
12000	0.50	1.16	1.27	1.27	0.27	0.48	0.82	1.09	2.28

Z200-24									
Span	Inward				Outward				Def 'n L/150
	0	1	2	3	0	1	2	3	
3000	18.89	18.89	18.89	18.89	18.89	18.89	18.89	18.89	40.82
3500	13.86	16.19	16.19	16.19	16.19	16.19	16.19	16.19	25.71
4000	9.62	14.17	14.17	14.17	14.17	14.17	14.17	14.17	17.22
4500	7.01	12.45	12.45	12.45	11.14	12.45	12.45	12.45	12.10
5000	5.32	10.08	10.08	10.08	8.25	10.08	10.08	10.09	8.82
5500	4.17	8.33	8.33	8.33	6.13	8.17	8.33	8.33	6.63
6000	3.35	6.99	7.00	7.00	4.54	6.60	7.00	7.00	5.10
6500	2.74	5.89	5.97	5.97	3.37	5.37	5.97	5.97	4.01
7000	2.28	5.01	5.14	5.15	2.56	4.35	5.14	5.15	3.21
7500	1.93	4.31	4.48	4.48	1.98	3.54	4.37	4.48	2.61
8000	1.65	3.74	3.94	3.94	1.57	2.87	3.73	3.94	2.15
8500	1.42	3.28	3.49	3.49	1.26	2.33	3.20	3.49	1.80
9000	1.23	2.90	3.11	3.11	1.02	1.88	2.73	3.10	1.51
9500	1.08	2.58	2.79	2.79	0.84	1.53	2.34	2.72	1.29
10000	0.95	2.30	2.52	2.52	0.70	1.26	2.00	2.40	1.10
10500	0.84	2.06	2.27	2.29	0.59	1.05	1.71	2.13	0.95
11000	0.75	1.86	2.06	2.08	0.50	0.88	1.46	1.88	0.83
11500	0.67	1.68	1.87	1.91	0.43	0.74	1.25	1.66	0.73
12000	0.60	1.52	1.71	1.75	0.37	0.63	1.06	1.47	0.64

**NOTE:** Bolting of section sizes from 100 to 250mm inclusive requires M12 grade 4.6 bolts. 300mm and 350mm sections require M16 grade 4.6 bolts. Shaded values require grade 8.8 bolts.

# DESIGN CAPACITY TABLES

Three lapped spans are continuous over three bays, supported at each end of the purlin and lapped over two internal supports.

(Tables in kN/m)



# 3 LAPPED

Z250-15									
Span	Inward				Outward				Def 'n L/150
	0	1	2	3	0	1	2	3	
3000	7.39	7.39	7.39	7.39	7.39	7.39	7.39	7.39	40.75
3500	6.23	6.23	6.23	6.23	6.23	6.23	6.23	6.23	25.66
4000	5.35	5.35	5.35	5.35	5.35	5.35	5.35	5.35	17.19
4500	4.67	4.67	4.67	4.67	4.67	4.67	4.67	4.67	12.07
5000	4.11	4.11	4.10	4.11	4.11	4.11	4.10	4.11	8.80
5500	3.65	3.65	3.65	3.65	3.65	3.65	3.65	3.65	6.61
6000	3.20	3.27	3.27	3.27	3.27	3.27	3.27	3.27	5.09
6500	2.63	2.95	2.95	2.95	2.62	2.95	2.95	2.95	4.01
7000	2.20	2.67	2.67	2.67	2.04	2.67	2.67	2.67	3.21
7500	1.86	2.43	2.43	2.43	1.59	2.43	2.43	2.43	2.61
8000	1.59	2.22	2.22	2.22	1.24	2.08	2.22	2.22	2.15
8500	1.38	2.03	2.03	2.03	0.98	1.74	2.03	2.03	1.79
9000	1.20	1.87	1.87	1.87	0.79	1.42	1.85	1.87	1.51
9500	1.04	1.73	1.73	1.73	0.64	1.16	1.61	1.73	1.28
10000	0.90	1.60	1.60	1.60	0.53	0.98	1.40	1.59	1.10
10500	0.79	1.45	1.46	1.46	0.44	0.82	1.23	1.41	0.95
11000	0.69	1.31	1.33	1.33	0.37	0.68	1.07	1.26	0.83
11500	0.61	1.19	1.22	1.22	0.31	0.57	0.93	1.13	0.72
12000	0.54	1.08	1.12	1.12	0.27	0.49	0.80	1.01	0.64

Z250-19									
Span	Inward				Outward				Def 'n L/150
	0	1	2	3	0	1	2	3	
3000	14.43	14.43	14.43	14.43	14.43	14.43	14.43	14.43	53.32
3500	12.01	12.01	12.01	12.00	12.01	12.01	12.01	12.01	33.57
4000	10.18	10.18	10.18	10.18	10.18	10.18	10.18	10.18	22.49
4500	7.76	8.75	8.75	8.75	8.75	8.75	8.75	8.75	15.80
5000	5.89	7.60	7.60	7.60	7.60	7.60	7.60	7.60	11.52
5500	4.62	6.67	6.67	6.67	6.18	6.67	6.67	6.67	8.65
6000	3.70	5.89	5.89	5.89	4.69	5.89	5.89	5.89	6.66
6500	3.03	5.24	5.24	5.24	3.50	5.18	5.24	5.24	5.24
7000	2.52	4.65	4.65	4.65	2.64	4.22	4.65	4.65	4.20
7500	2.12	4.05	4.05	4.05	2.03	3.48	4.05	4.05	3.41
8000	1.80	3.56	3.56	3.56	1.59	2.87	3.56	3.56	2.81
8500	1.54	3.15	3.15	3.15	1.26	2.37	3.08	3.15	2.34
9000	1.33	2.81	2.81	2.81	1.02	1.92	2.64	2.81	1.98
9500	1.16	2.52	2.52	2.52	0.83	1.56	2.27	2.52	1.68
10000	1.02	2.28	2.28	2.28	0.69	1.27	1.96	2.28	1.44
10500	0.89	2.05	2.07	2.07	0.57	1.05	1.70	2.05	1.24
11000	0.79	1.84	1.88	1.88	0.48	0.88	1.47	1.81	1.08
11500	0.70	1.67	1.72	1.72	0.41	0.74	1.27	1.60	0.95
12000	0.62	1.51	1.58	1.58	0.35	0.63	1.08	1.42	0.83

Z250-24									
Span	Inward				Outward				Def 'n L/150
	0	1	2	3	0	1	2	3	
3000	18.89	18.89	18.89	18.89	18.89	18.89	18.89	18.89	68.99
3500	16.19	16.19	16.19	16.19	16.19	16.19	16.19	16.19	43.44
4000	11.93	14.17	14.17	14.17	14.17	14.17	14.17	14.17	29.10
4500	8.66	12.59	12.59	12.59	12.59	12.59	12.60	12.60	20.44
5000	6.56	11.33	11.33	11.33	10.97	11.33	11.33	11.33	14.90
5500	5.13	10.30	10.30	10.30	8.20	10.30	10.30	10.30	11.20
6000	4.11	8.84	8.84	8.84	6.01	8.66	8.84	8.84	8.62
6500	3.36	7.53	7.53	7.53	4.44	7.04	7.53	7.53	6.78
7000	2.80	6.49	6.49	6.50	3.35	5.74	6.49	6.50	5.43
7500	2.36	5.58	5.66	5.66	2.59	4.71	5.66	5.66	4.42
8000	2.01	4.85	4.97	4.97	2.03	3.82	4.88	4.97	3.64
8500	1.73	4.25	4.40	4.41	1.62	3.07	4.18	4.41	3.03
9000	1.50	3.74	3.93	3.93	1.31	2.46	3.59	3.93	2.56
9500	1.31	3.32	3.53	3.53	1.08	2.00	3.08	3.53	2.17
10000	1.16	2.96	3.18	3.18	0.89	1.64	2.66	3.14	1.86
10500	1.02	2.65	2.89	2.89	0.75	1.36	2.28	2.79	1.61
11000	0.91	2.39	2.63	2.63	0.63	1.14	1.94	2.46	1.40
11500	0.81	2.16	2.41	2.41	0.54	0.96	1.64	2.18	1.23
12000	0.73	1.96	2.21	2.21	0.46	0.82	1.39	1.94	1.08
12500	0.65	1.79	2.03	2.04	0.40	0.70	1.19	1.72	0.95
13000	0.59	1.63	1.86	1.88	0.35	0.60	1.02	1.53	0.85
13500	0.53	1.49	1.72	1.75	0.31	0.52	0.88	1.35	0.76
14000	0.48	1.36	1.59	1.62	0.27	0.46	0.76	1.18	0.68

**NOTE:** Bolting of section sizes from 100 to 250mm inclusive requires M12 grade 4.6 bolts. 300mm and 350mm sections require M16 grade 4.6 bolts. Shaded values require grade 8.8 bolts.

# 3 LAPPED

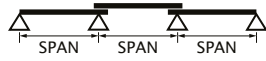

# DESIGN CAPACITY TABLES

Three lapped spans are continuous over three bays, supported at each end of the purlin and lapped over two internal supports.

(Tables in kN/m)

Z300-19									
Span	Inward				Outward				Def 'n L/150
	0	1	2	3	0	1	2	3	
3000	12.56	12.56	12.56	12.56	12.56	12.56	12.56	12.56	93.27
3500	10.62	10.62	10.62	10.62	10.62	10.62	10.62	10.62	58.73
4000	9.16	9.16	9.16	9.16	9.16	9.16	9.16	9.16	39.35
4500	8.01	8.01	8.01	8.01	8.01	8.01	8.01	8.01	27.64
5000	7.09	7.09	7.09	7.09	7.09	7.09	7.09	7.09	20.15
5500	6.32	6.32	6.32	6.32	6.32	6.32	6.32	6.32	15.14
6000	5.26	5.68	5.69	5.69	5.68	5.69	5.69	5.69	11.66
6500	4.30	5.14	5.14	5.14	5.14	5.14	5.14	5.14	9.17
7000	3.60	4.67	4.68	4.68	4.67	4.67	4.68	4.68	7.34
7500	3.05	4.27	4.27	4.27	4.27	4.27	4.27	4.27	5.97
8000	2.58	3.91	3.91	3.91	3.44	3.91	3.91	3.91	4.92
8500	2.22	3.60	3.60	3.60	2.77	3.60	3.60	3.60	4.10
9000	1.92	3.32	3.32	3.32	2.26	3.32	3.32	3.32	3.45
9500	1.67	3.08	3.08	3.08	1.90	3.00	3.08	3.08	2.94
10000	1.47	2.86	2.86	2.86	1.56	2.61	2.86	2.86	2.52
10500	1.30	2.66	2.66	2.66	1.29	2.27	2.66	2.66	2.18
11000	1.16	2.45	2.48	2.48	1.08	1.94	2.42	2.48	1.89
11500	1.04	2.23	2.31	2.31	0.92	1.65	2.17	2.31	1.66
12000	0.93	2.03	2.13	2.13	0.78	1.42	1.95	2.13	1.46
12500	0.84	1.86	1.97	1.97	0.67	1.22	1.75	1.96	1.29
13000	0.76	1.71	1.82	1.82	0.58	1.07	1.58	1.79	1.15
13500	0.69	1.58	1.69	1.69	0.50	0.94	1.42	1.63	1.02
14000	0.63	1.46	1.57	1.57	0.43	0.82	1.28	1.49	0.92

Z300-24									
Span	Inward				Outward				Def 'n L/150
	0	1	2	3	0	1	2	3	
3000	24.55	24.55	24.55	24.55	24.55	24.55	24.55	24.55	121.06
3500	20.55	20.55	20.55	20.55	20.55	20.55	20.55	20.55	76.23
4000	17.52	17.52	17.52	17.52	17.52	17.52	17.52	17.52	51.07
4500	13.80	15.14	15.14	15.14	15.14	15.14	15.14	15.14	35.87
5000	10.18	13.23	13.23	13.23	13.23	13.23	13.23	13.23	26.15
5500	7.77	11.66	11.66	11.66	11.66	11.66	11.66	11.66	19.65
6000	6.11	10.36	10.36	10.36	10.36	10.36	10.36	10.36	15.13
6500	4.92	9.26	9.26	9.26	8.79	9.26	9.26	9.26	11.90
7000	4.04	8.32	8.33	8.33	7.04	8.32	8.33	8.33	9.53
7500	3.37	7.52	7.52	7.52	5.68	7.52	7.52	7.52	7.75
8000	2.86	6.74	6.74	6.74	4.57	6.58	6.74	6.74	6.38
8500	2.45	5.97	5.97	5.97	3.67	5.60	5.97	5.97	5.35
9000	2.12	5.26	5.33	5.33	2.95	4.77	5.33	5.33	4.50
9500	1.85	4.65	4.78	4.78	2.40	4.08	4.78	4.78	3.83
10000	1.63	4.13	4.32	4.32	1.98	3.49	4.32	4.32	3.28
10500	1.44	3.70	3.91	3.91	1.65	3.00	3.87	3.91	2.84
11000	1.28	3.32	3.57	3.57	1.38	2.58	3.42	3.57	2.47
11500	1.15	3.00	3.26	3.26	1.17	2.22	3.04	3.26	2.16
12000	1.04	2.72	3.00	3.00	1.00	1.90	2.70	3.00	1.90
12500	0.94	2.48	2.76	2.76	0.86	1.62	2.40	2.76	1.68
13000	0.85	2.26	2.55	2.55	0.74	1.39	2.13	2.55	1.50
13500	0.77	2.07	2.37	2.37	0.64	1.20	1.90	2.32	1.34
14000	0.71	1.91	2.20	2.20	0.56	1.05	1.70	2.11	1.20
14500	0.65	1.76	2.05	2.05	0.49	0.91	1.52	1.92	1.08
15000	0.59	1.62	1.91	1.92	0.44	0.80	1.36	1.75	0.97

Z300-30									
Span	Inward				Outward				Def 'n L/150
	0	1	2	3	0	1	2	3	
4000	23.96	26.78	26.78	26.78	26.78	26.78	26.78	26.78	66.00
4500	16.59	23.81	23.80	23.81	23.81	23.81	23.81	23.81	46.35
5000	12.07	21.42	21.42	21.42	21.42	21.42	21.42	21.42	33.79
5500	9.14	19.47	19.47	19.47	19.26	19.47	19.47	19.47	25.39
6000	7.13	17.06	17.06	17.06	15.45	17.06	17.06	17.06	19.56
6500	5.71	14.54	14.54	14.54	12.37	14.54	14.54	14.54	15.38
7000	4.67	12.43	12.53	12.54	9.83	12.53	12.53	12.54	12.32
7500	3.89	10.65	10.92	10.92	7.73	10.66	10.92	10.92	10.01
8000	3.28	9.21	9.60	9.60	6.06	9.12	9.60	9.60	8.25
8500	2.81	8.03	8.50	8.50	4.81	7.84	8.50	8.50	6.88
9000	2.43	7.06	7.58	7.58	3.88	6.73	7.58	7.58	5.79
9500	2.12	6.24	6.80	6.81	3.16	5.78	6.79	6.81	4.93
10000	1.86	5.53	6.14	6.14	2.61	4.94	6.02	6.14	4.22
10500	1.65	4.93	5.57	5.57	2.17	4.19	5.35	5.57	3.65
11000	1.47	4.41	5.07	5.08	1.83	3.54	4.77	5.08	3.17
11500	1.32	3.97	4.59	4.64	1.55	2.99	4.27	4.64	2.78
12000	1.19	3.59	4.18	4.27	1.33	2.53	3.80	4.26	2.46
12500	1.08	3.26	3.82	3.93	1.14	2.16	3.39	3.87	2.17
13000	0.98	2.96	3.50	3.63	0.99	1.86	3.03	3.52	1.93
13500	0.89	2.70	3.22	3.37	0.86	1.61	2.68	3.22	1.73
14000	0.82	2.46	2.96	3.13	0.76	1.40	2.37	2.94	1.55
14500	0.75	2.26	2.74	2.92	0.67	1.22	2.09	2.69	1.39
15000	0.69	2.07	2.54	2.72	0.59	1.08	1.85	2.46	1.26

**NOTE:** Bolting of section sizes from 100 to 250mm inclusive requires M12 grade 4.6 bolts. 300mm and 350mm sections require M16 grade 4.6 bolts. Shaded values require grade 8.8 bolts.



# DESIGN CAPACITY TABLES

Three lapped spans are continuous over three bays, supported at each end of the purlin and lapped over two internal supports.

(Tables in kN/m)



# 3 LAPPED

Z350-19									
Span	Inward				Outward				Def 'n L/150
	0	1	2	3	0	1	2	3	
3000	10.91	10.91	10.91	10.92	10.91	10.91	10.91	10.91	152.11
3500	9.30	9.30	9.30	9.30	9.30	9.30	9.30	9.30	95.80
4000	8.08	8.08	8.08	8.08	8.08	8.08	8.08	8.08	64.18
4500	7.13	7.13	7.13	7.12	7.13	7.13	7.13	7.13	45.07
5000	6.36	6.36	6.36	6.36	6.36	6.36	6.36	6.36	32.86
5500	5.72	5.72	5.72	5.72	5.72	5.72	5.72	5.72	24.69
6000	5.20	5.20	5.20	5.20	5.20	5.20	5.20	5.20	19.02
6500	4.75	4.75	4.75	4.75	4.75	4.75	4.75	4.75	14.96
7000	4.36	4.36	4.36	4.36	4.36	4.36	4.36	4.36	11.98
7500	4.02	4.02	4.02	4.02	4.02	4.02	4.02	4.02	9.74
8000	3.50	3.72	3.72	3.72	3.73	3.72	3.72	3.72	8.02
8500	2.99	3.46	3.46	3.46	3.46	3.46	3.46	3.46	6.69
9000	2.58	3.23	3.23	3.23	3.23	3.23	3.23	3.23	5.63
9500	2.25	3.01	3.01	3.01	3.01	3.01	3.01	3.01	4.79
10000	1.98	2.83	2.83	2.83	2.83	2.83	2.83	2.83	4.11
10500	1.75	2.65	2.65	2.65	2.52	2.65	2.65	2.65	3.55
11000	1.56	2.50	2.50	2.50	2.18	2.50	2.50	2.50	3.09
11500	1.40	2.35	2.35	2.35	1.85	2.35	2.35	2.35	2.70
12000	1.26	2.22	2.22	2.22	1.59	2.22	2.22	2.22	2.38
12500	1.14	2.10	2.10	2.10	1.37	2.10	2.10	2.10	2.10
13000	1.03	1.99	1.99	1.99	1.19	1.99	1.99	1.99	1.87
13500	0.94	1.89	1.89	1.89	1.04	1.73	1.89	1.89	1.67
14000	0.86	1.79	1.79	1.79	0.91	1.55	1.79	1.79	1.50
14500	0.79	1.70	1.70	1.70	0.80	1.38	1.70	1.70	1.35
15000	0.73	1.61	1.62	1.62	0.71	1.24	1.61	1.62	1.22

Z350-24									
Span	Inward				Outward				Def 'n L/150
	0	1	2	3	0	1	2	3	
4000	15.88	15.88	15.88	15.88	15.88	15.88	15.88	15.88	83.32
4500	13.91	13.91	13.91	13.91	13.91	13.91	13.91	13.91	58.51
5000	12.33	12.33	12.33	12.33	12.33	12.33	12.33	12.33	42.66
5500	11.01	11.01	11.01	11.01	11.01	11.01	11.01	11.01	32.05
6000	9.23	9.93	9.93	9.93	9.92	9.93	9.93	9.93	24.69
6500	7.39	8.99	8.99	8.99	8.99	8.99	8.99	8.99	19.42
7000	6.08	8.18	8.19	8.19	8.19	8.18	8.19	8.19	15.55
7500	4.99	7.49	7.49	7.49	7.49	7.49	7.49	7.49	12.64
8000	4.16	6.88	6.88	6.88	6.88	6.88	6.88	6.88	10.41
8500	3.52	6.34	6.34	6.34	6.34	6.34	6.34	6.34	8.68
9000	3.01	5.87	5.87	5.87	5.75	5.87	5.87	5.87	7.31
9500	2.61	5.44	5.44	5.44	4.79	5.44	5.44	5.44	6.22
10000	2.28	5.06	5.06	5.06	4.00	5.06	5.06	5.06	5.36
10500	2.00	4.71	4.71	4.71	3.36	4.71	4.71	4.71	4.63
11000	1.78	4.40	4.40	4.40	2.86	4.35	4.40	4.40	4.03
11500	1.58	4.06	4.12	4.12	2.44	3.89	4.12	4.12	3.52
12000	1.42	3.69	3.86	3.86	2.12	3.48	3.86	3.86	3.10
12500	1.28	3.37	3.61	3.61	1.83	3.12	3.60	3.61	2.74
13000	1.16	3.09	3.34	3.34	1.58	2.77	3.29	3.34	2.44
13500	1.06	2.84	3.10	3.10	1.36	2.43	3.01	3.10	2.18
14000	0.96	2.61	2.88	2.88	1.19	2.14	2.75	2.88	1.95
14500	0.88	2.41	2.68	2.69	1.04	1.89	2.53	2.69	1.76
15000	0.81	2.24	2.51	2.51	0.91	1.67	2.32	2.51	1.59
15500	0.75	2.08	2.33	2.35	0.81	1.49	2.13	2.35	1.44
16000	0.69	1.93	2.18	2.21	0.72	1.33	1.96	2.19	1.31
16500	0.64	1.80	2.04	2.07	0.64	1.19	1.81	2.04	1.19
17000	0.60	1.69	1.91	1.95	0.57	1.07	1.67	1.90	1.09
17500	0.55	1.58	1.79	1.84	0.51	0.98	1.52	1.77	1.00
18000	0.52	1.47	1.68	1.74	0.46	0.88	1.38	1.66	0.92

Z350-30									
Span	Inward				Outward				Def 'n L/150
	0	1	2	3	0	1	2	3	
4000	26.78	26.78	26.78	26.78	26.78	26.78	26.78	26.78	107.39
4500	23.80	23.80	23.80	23.80	23.80	23.80	23.81	23.80	75.42
5000	19.56	21.42	21.42	21.42	21.42	21.42	21.42	21.42	54.98
5500	14.59	19.47	19.47	19.47	19.47	19.47	19.47	19.48	41.31
6000	11.10	17.81	17.81	17.81	17.80	17.80	17.80	17.80	31.82
6500	8.69	15.96	15.96	15.96	15.96	15.96	15.96	15.96	25.03
7000	6.96	14.39	14.39	14.39	14.40	14.40	14.40	14.40	20.04
7500	5.69	13.04	13.04	13.04	12.61	13.04	13.04	13.04	16.29
8000	4.73	11.86	11.86	11.86	10.52	11.86	11.86	11.86	13.42
8500	3.99	10.80	10.80	10.80	8.79	10.80	10.80	10.80	11.19
9000	3.41	9.56	9.63	9.63	7.33	9.64	9.64	9.64	9.43
9500	2.94	8.42	8.65	8.65	6.17	8.58	8.65	8.65	8.02
10000	2.56	7.45	7.80	7.80	5.22	7.53	7.80	7.80	6.87
10500	2.25	6.63	7.08	7.08	4.41	6.63	7.08	7.08	5.94
11000	1.99	5.93	6.45	6.45	3.74	5.84	6.45	6.45	5.16
11500	1.78	5.32	5.90	5.90	3.15	5.16	5.90	5.90	4.52
12000	1.59	4.79	5.42	5.42	2.68	4.55	5.42	5.42	3.98
12500	1.44	4.34	4.99	4.99	2.30	4.02	4.99	4.99	3.52
13000	1.30	3.94	4.62	4.62	1.98	3.55	4.54	4.62	3.13
13500	1.18	3.58	4.28	4.28	1.72	3.14	4.12	4.28	2.79
14000	1.08	3.27	3.98	3.98	1.50	2.79	3.74	3.98	2.51
14500	0.99	3.00	3.69	3.71	1.31	2.49	3.41	3.71	2.25
15000	0.91	2.75	3.41	3.47	1.16	2.21	3.10	3.47	2.04
15500	0.84	2.53	3.16	3.25	1.02	1.97	2.83	3.25	1.85
16000	0.78	2.34	2.93	3.05	0.91	1.75	2.58	3.04	1.69
16500	0.72	2.16	2.73	2.87	0.81	1.55	2.35	2.81	1.54
17000	0.67	2.01	2.54	2.70	0.73	1.38	2.14	2.61	1.41
17500	0.63	1.87	2.37	2.55	0.65	1.24	1.95	2.42	1.29
18000	0.58	1.74	2.22	2.41	0.59	1.11	1.78	2.24	1.18

**NOTE:** Bolting of section sizes from 100 to 250mm inclusive requires M12 grade 4.6 bolts. 300mm and 350mm sections require M16 grade 4.6 bolts. Shaded values require grade 8.8 bolts.

# 4 LAPPED

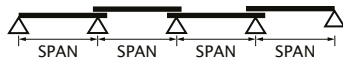

## DESIGN CAPACITY TABLES

Four lapped spans are continuous over four bays, supported at each end of the purlin and lapped over three internal supports.

(Tables in kN/m)

Z150-10									
Span	Inward				Outward				Def'n L/150
	0	1	2	3	0	1	2	3	
2000	5.51	5.51	5.51	5.51	5.51	5.51	5.51	5.51	26.43
2500	4.29	4.29	4.29	4.29	4.29	4.29	4.29	4.29	13.53
3000	3.46	3.46	3.46	3.46	3.46	3.46	3.46	3.46	7.83
3500	2.86	2.86	2.86	2.86	2.86	2.86	2.86	2.86	4.93
4000	2.41	2.41	2.41	2.41	2.41	2.41	2.41	2.41	3.30
4500	2.06	2.06	2.06	2.06	2.06	2.06	2.06	2.06	2.32
5000	1.78	1.78	1.78	1.78	1.60	1.78	1.78	1.78	1.69
5500	1.52	1.55	1.55	1.55	1.14	1.55	1.55	1.55	1.27
6000	1.25	1.37	1.37	1.37	0.83	1.31	1.37	1.37	0.98
6500	1.03	1.21	1.21	1.21	0.62	1.04	1.21	1.21	0.77
7000	0.86	1.08	1.08	1.08	0.48	0.81	1.05	1.08	0.62
7500	0.72	0.95	0.95	0.95	0.37	0.63	0.88	0.95	0.50
8000	0.60	0.84	0.84	0.84	0.30	0.50	0.74	0.84	0.41
8500	0.51	0.74	0.74	0.74	0.24	0.40	0.62	0.73	0.34
9000	0.43	0.66	0.66	0.66	0.19	0.32	0.52	0.63	0.29
9500	0.37	0.59	0.59	0.59	0.16	0.26	0.43	0.55	0.25
10000	0.32	0.53	0.54	0.54	0.13	0.22	0.35	0.48	0.21

Z150-12									
Span	Inward				Outward				Def'n L/150
	0	1	2	3	0	1	2	3	
2000	9.13	9.13	9.13	9.13	9.13	9.13	9.13	9.13	32.86
2500	6.96	6.96	6.96	6.96	6.96	6.96	6.96	6.96	16.83
3000	5.51	5.51	5.51	5.51	5.50	5.50	5.50	5.50	9.74
3500	4.46	4.46	4.46	4.46	4.46	4.46	4.46	4.46	6.13
4000	3.69	3.69	3.69	3.69	3.69	3.69	3.69	3.69	4.11
4500	2.91	3.09	3.09	3.09	2.85	3.09	3.09	3.09	2.89
5000	2.28	2.63	2.63	2.63	2.03	2.63	2.63	2.63	2.10
5500	1.83	2.19	2.19	2.19	1.45	2.15	2.19	2.19	1.58
6000	1.48	1.84	1.84	1.84	1.06	1.69	1.84	1.84	1.22
6500	1.22	1.57	1.57	1.57	0.80	1.33	1.57	1.57	0.96
7000	1.01	1.35	1.35	1.35	0.61	1.04	1.35	1.35	0.77
7500	0.84	1.18	1.18	1.18	0.47	0.81	1.14	1.18	0.62
8000	0.71	1.03	1.03	1.03	0.37	0.64	0.95	1.04	0.51
8500	0.60	0.92	0.92	0.92	0.29	0.51	0.79	0.92	0.43
9000	0.52	0.82	0.82	0.82	0.24	0.41	0.66	0.82	0.36
9500	0.44	0.73	0.73	0.73	0.19	0.34	0.55	0.71	0.31
10000	0.38	0.66	0.66	0.66	0.16	0.28	0.45	0.62	0.26

Z150-15									
Span	Inward				Outward				Def'n L/150
	0	1	2	3	0	1	2	3	
2000	15.77	15.77	15.77	15.77	15.77	15.77	15.77	15.77	41.73
2500	11.50	11.50	11.50	11.50	11.50	11.50	11.50	11.50	21.37
3000	8.27	8.72	8.72	8.72	8.72	8.72	8.72	8.72	12.37
3500	5.90	6.79	6.79	6.79	6.68	6.79	6.79	6.79	7.79
4000	4.40	5.28	5.28	5.28	4.78	5.28	5.28	5.28	5.22
4500	3.40	4.17	4.17	4.17	3.52	4.17	4.17	4.17	3.66
5000	2.69	3.38	3.38	3.38	2.62	3.28	3.38	3.38	2.67
5500	2.15	2.79	2.79	2.79	1.90	2.58	2.79	2.79	2.01
6000	1.75	2.35	2.35	2.35	1.37	2.05	2.35	2.35	1.55
6500	1.44	2.00	2.00	2.00	1.02	1.66	1.97	2.00	1.22
7000	1.20	1.73	1.73	1.73	0.77	1.35	1.64	1.73	0.97
7500	1.00	1.50	1.50	1.50	0.60	1.07	1.37	1.50	0.79
8000	0.85	1.32	1.32	1.32	0.47	0.84	1.16	1.31	0.65
8500	0.72	1.17	1.17	1.17	0.38	0.66	0.99	1.13	0.54
9000	0.62	1.03	1.04	1.04	0.31	0.53	0.85	0.98	0.46
9500	0.53	0.91	0.94	0.94	0.25	0.43	0.72	0.85	0.39
10000	0.46	0.81	0.85	0.85	0.21	0.36	0.60	0.75	0.33

Z150-19									
Span	Inward				Outward				Def'n L/150
	0	1	2	3	0	1	2	3	
2000	26.51	26.51	26.51	26.51	26.51	26.51	26.51	26.51	53.51
2500	16.27	18.27	18.27	18.27	18.27	18.27	18.27	18.27	27.40
3000	10.59	13.03	13.03	13.03	13.03	13.03	13.03	13.03	15.85
3500	7.35	9.57	9.57	9.57	9.21	9.57	9.57	9.57	9.98
4000	5.36	7.33	7.33	7.33	6.52	7.33	7.33	7.33	6.69
4500	4.05	5.79	5.79	5.79	4.68	5.78	5.79	5.79	4.70
5000	3.15	4.69	4.69	4.69	3.39	4.54	4.69	4.69	3.42
5500	2.50	3.88	3.88	3.88	2.45	3.55	3.88	3.88	2.57
6000	2.02	3.26	3.26	3.26	1.78	2.80	3.26	3.26	1.98
6500	1.65	2.78	2.78	2.78	1.33	2.22	2.71	2.78	1.56
7000	1.37	2.39	2.39	2.39	1.01	1.76	2.27	2.39	1.25
7500	1.16	2.08	2.08	2.08	0.79	1.39	1.89	2.08	1.02
8000	0.98	1.81	1.83	1.83	0.63	1.10	1.58	1.81	0.84
8500	0.84	1.59	1.62	1.62	0.51	0.87	1.33	1.57	0.70
9000	0.72	1.41	1.45	1.45	0.42	0.70	1.11	1.36	0.59
9500	0.63	1.25	1.30	1.30	0.35	0.57	0.93	1.18	0.50
10000	0.55	1.11	1.17	1.17	0.29	0.47	0.78	1.02	0.43

Z150-24									
Span	Inward				Outward				Def'n L/150
	0	1	2	3	0	1	2	3	
3000	12.64	17.70	17.70	17.70	16.81	17.70	17.70	17.70	20.10
3500	8.69	13.00	13.00	13.00	11.56	13.00	13.00	13.00	12.66
4000	6.28	9.96	9.96	9.96	8.19	9.76	9.96	9.96	8.48
4500	4.71	7.74	7.86	7.86	5.91	7.40	7.86	7.86	5.96
5000	3.64	6.18	6.37	6.37	4.31	5.72	6.37	6.37	4.34
5500	2.89	5.03	5.26	5.26	3.15	4.48	5.12	5.26	3.26
6000	2.34	4.17	4.43	4.43	2.31	3.55	4.18	4.43	2.51
6500	1.93	3.51	3.77	3.77	1.74	2.83	3.44	3.75	1.98
7000	1.61	3.00	3.24	3.25	1.34	2.26	2.85	3.16	1.58
7500	1.36	2.58	2.80	2.83	1.06	1.81	2.38	2.69	1.29
8000	1.16	2.25	2.44	2.49	0.85	1.44	2.00	2.30	1.06
8500	1.00	1.97	2.14	2.20	0.69	1.15	1.69	1.98	0.88
9000	0.87	1.73	1.90	1.97	0.57	0.94	1.42	1.71	0.75
9500	0.76	1.54	1.69	1.76	0.48	0.77	1.20	1.48	0.63
10000	0.67	1.37	1.52	1.58	0.40	0.64	1.02	1.29	0.54
10500	0.60	1.22	1.37	1.42	0.35	0.54	0.86	1.13	0.47
11000	0.53	1.09	1.23	1.29	0.30	0.46	0.72	0.99	0.41
11500	0.47	0.98	1.11	1.17	0.26	0.39	0.61	0.86	0.36
12000	0.42	0.88	1.01	1.06	0.23	0.34	0.52	0.75	0.31

**NOTE:**

Bolting of section sizes from 100 to 250mm inclusive requires M12 grade 4.6 bolts.  
 300mm and 350mm sections require M16 grade 4.6 bolts.  
 Shaded values require grade 8.8 bolts.

# DESIGN CAPACITY TABLES

Four lapped spans are continuous over four bays, supported at each end of the purlin and lapped over three internal supports.

(Tables in kN/m)

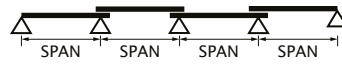

# 4 LAPPED

Z200-12									
Span	Inward				Outward				Def 'n L/150
	0	1	2	3	0	1	2	3	
2000	7.16	7.16	7.16	7.16	7.16	7.16	7.16	7.16	68.71
2500	5.64	5.64	5.64	5.64	5.64	5.64	5.64	5.64	35.18
3000	4.61	4.61	4.61	4.61	4.61	4.61	4.61	4.61	20.36
3500	3.86	3.86	3.86	3.86	3.86	3.86	3.86	3.86	12.82
4000	3.30	3.30	3.30	3.90	3.30	3.30	3.30	3.30	8.59
4500	2.85	2.85	2.85	2.85	2.85	2.85	2.85	2.85	6.03
5000	2.50	2.50	2.50	2.50	2.50	2.50	2.50	2.50	4.40
5500	2.21	2.21	2.21	2.21	2.21	2.21	2.21	2.21	3.30
6000	1.96	1.96	1.96	1.96	1.96	1.96	1.96	1.96	2.55
6500	1.75	1.76	1.76	1.76	1.57	1.76	1.76	1.76	2.00
7000	1.47	1.58	1.58	1.58	1.20	1.58	1.58	1.58	1.60
7500	1.26	1.43	1.43	1.43	0.94	1.43	1.43	1.43	1.30
8000	1.08	1.30	1.30	1.30	0.74	1.20	1.30	1.30	1.07
8500	0.93	1.18	1.18	1.18	0.60	1.00	1.18	1.18	0.90
9000	0.80	1.08	1.08	1.08	0.48	0.83	1.07	1.08	0.75
9500	0.69	1.00	1.00	1.00	0.40	0.68	0.93	1.00	0.64
10000	0.61	0.92	0.92	0.92	0.33	0.56	0.81	0.92	0.55

Z200-15									
Span	Inward				Outward				Def 'n L/150
	0	1	2	3	0	1	2	3	
2000	13.56	13.56	13.56	13.56	13.56	13.56	13.56	13.56	89.57
2500	10.49	10.49	10.49	10.49	10.49	10.49	10.49	10.49	45.86
3000	8.42	8.42	8.42	8.42	8.42	8.42	8.42	8.42	26.54
3500	6.92	6.92	6.92	6.92	6.92	6.92	6.92	6.92	16.71
4000	5.80	5.80	5.80	5.80	5.80	5.80	5.80	5.80	11.20
4500	4.92	4.92	4.92	4.92	4.92	4.92	4.92	4.92	7.86
5000	3.86	4.23	4.23	4.23	4.23	4.23	4.23	4.23	5.73
5500	3.07	3.67	3.67	3.67	3.48	3.67	3.67	3.67	4.31
6000	2.50	3.21	3.21	3.21	2.65	3.21	3.21	3.21	3.32
6500	2.05	2.83	2.83	2.83	2.01	2.83	2.83	2.83	2.61
7000	1.72	2.49	2.49	2.49	1.56	2.36	2.49	2.49	2.09
7500	1.45	2.17	2.17	2.17	1.24	1.94	2.17	2.17	1.70
8000	1.24	1.91	1.91	1.91	0.97	1.60	1.91	1.91	1.40
8500	1.07	1.69	1.69	1.69	0.77	1.31	1.69	1.69	1.17
9000	0.93	1.51	1.51	1.51	0.62	1.07	1.47	1.51	0.98
9500	0.82	1.35	1.35	1.35	0.51	0.88	1.26	1.35	0.84
10000	0.72	1.22	1.22	1.22	0.42	0.75	1.09	1.22	0.72

Z200-19									
Span	Inward				Outward				Def 'n L/150
	0	1	2	3	0	1	2	3	
2000	26.05	26.05	26.05	26.05	26.05	26.05	26.05	26.05	117.70
2500	19.65	19.65	19.65	19.65	19.65	19.65	19.65	19.65	60.26
3000	15.36	15.36	15.36	15.36	15.36	15.36	15.36	15.36	34.87
3500	11.64	12.32	12.32	12.32	12.32	12.32	12.32	12.32	21.96
4000	8.46	10.09	10.09	10.09	10.09	10.09	10.09	10.09	14.71
4500	6.25	8.39	8.39	8.39	8.16	8.39	8.39	8.39	10.33
5000	4.77	7.05	7.05	7.05	6.23	7.05	7.05	7.05	7.53
5500	3.74	5.84	5.84	5.84	4.85	5.84	5.84	5.84	5.66
6000	3.00	4.91	4.91	4.91	3.79	4.78	4.91	4.91	4.36
6500	2.46	4.18	4.18	4.18	2.84	3.91	4.18	4.18	3.43
7000	2.04	3.61	3.61	3.61	2.15	3.22	3.61	3.61	2.75
7500	1.72	3.14	3.14	3.14	1.66	2.69	3.14	3.14	2.23
8000	1.46	2.76	2.76	2.76	1.30	2.26	2.70	2.76	1.84
8500	1.26	2.43	2.45	2.45	1.04	1.90	2.32	2.45	1.53
9000	1.09	2.15	2.18	2.18	0.84	1.54	2.00	2.18	1.29
9500	0.95	1.91	1.96	1.96	0.69	1.25	1.74	1.96	1.10
10000	0.84	1.71	1.77	1.77	0.57	1.03	1.52	1.74	0.94

Z200-24									
Span	Inward				Outward				Def 'n L/150
	0	1	2	3	0	1	2	3	
3000	18.01	18.01	18.01	18.01	18.01	18.01	18.01	18.01	44.57
3500	13.93	15.44	15.44	15.44	15.44	15.44	15.44	15.44	28.06
4000	9.72	13.51	13.51	13.51	13.51	13.51	13.51	13.51	18.80
4500	7.09	12.01	12.01	12.01	11.16	12.01	12.01	12.01	13.20
5000	5.38	9.77	9.77	9.77	8.39	9.77	9.77	9.77	9.63
5500	4.21	8.07	8.07	8.07	6.34	8.05	8.07	8.07	7.23
6000	3.38	6.79	6.79	6.79	4.80	6.54	6.79	6.79	5.57
6500	2.77	5.77	5.78	5.78	3.61	5.36	5.78	5.78	4.38
7000	2.31	4.92	4.99	4.99	2.74	4.40	4.99	4.99	3.51
7500	1.95	4.24	4.34	4.34	2.13	3.60	4.31	4.34	2.85
8000	1.66	3.68	3.82	3.82	1.68	2.96	3.69	3.82	2.35
8500	1.43	3.23	3.38	3.38	1.35	2.43	3.18	3.38	1.96
9000	1.25	2.85	3.02	3.02	1.10	1.99	2.74	3.02	1.65
9500	1.09	2.54	2.71	2.71	0.90	1.62	2.36	2.69	1.40
10000	0.96	2.27	2.44	2.44	0.75	1.33	2.04	2.38	1.20
10500	0.86	2.04	2.22	2.22	0.63	1.11	1.76	2.11	1.04
11000	0.76	1.84	2.02	2.02	0.54	0.93	1.51	1.88	0.90
11500	0.68	1.66	1.84	1.85	0.46	0.79	1.30	1.67	0.79
12000	0.61	1.50	1.68	1.70	0.40	0.67	1.12	1.48	0.70

**NOTE:** Bolting of section sizes from 100 to 250mm inclusive requires M12 grade 4.6 bolts. 300mm and 350mm sections require M16 grade 4.6 bolts. Shaded values require grade 8.8 bolts.

# 4 LAPPED



## DESIGN CAPACITY TABLES

Four lapped spans are continuous over four bays, supported at each end of the purlin and lapped over three internal supports.

(Tables in kN/m)

Z250-15									
Span	Inward				Outward				Def 'n L/150
	0	1	2	3	0	1	2	3	
2000	11.11	11.11	11.11	11.11	11.11	11.11	11.11	11.11	150.14
2500	8.76	8.76	8.76	8.76	8.76	8.76	8.76	8.76	76.87
3000	7.18	7.18	7.18	7.18	7.18	7.18	7.18	7.18	44.49
3500	6.02	6.02	6.02	6.02	6.02	6.02	6.02	6.02	28.01
4000	5.16	5.16	5.16	5.16	5.16	5.16	5.16	5.15	18.77
4500	4.48	4.48	4.48	4.48	4.48	4.48	4.48	4.48	13.18
5000	3.93	3.93	3.93	3.93	3.93	3.93	3.93	3.93	9.61
5500	3.48	3.48	3.48	3.48	3.48	3.48	3.48	3.48	7.22
6000	3.11	3.11	3.11	3.11	3.11	3.11	3.11	3.11	5.56
6500	2.64	2.79	2.79	2.79	2.78	2.79	2.79	2.79	4.37
7000	2.20	2.52	2.52	2.52	2.13	2.52	2.52	2.52	3.50
7500	1.86	2.28	2.28	2.28	1.70	2.28	2.28	2.28	2.85
8000	1.59	2.08	2.08	2.08	1.34	2.08	2.08	2.08	2.35
8500	1.38	1.90	1.90	1.90	1.06	1.76	1.90	1.90	1.96
9000	1.20	1.74	1.74	1.74	0.85	1.48	1.74	1.74	1.65
9500	1.05	1.60	1.60	1.60	0.69	1.22	1.60	1.60	1.40
10000	0.93	1.48	1.48	1.48	0.57	1.01	1.40	1.48	1.20
10500	0.82	1.37	1.37	1.37	0.48	0.86	1.23	1.37	1.04
11000	0.72	1.27	1.27	1.27	0.40	0.72	1.08	1.25	0.90
11500	0.64	1.16	1.17	1.17	0.34	0.61	0.95	1.12	0.79
12000	0.57	1.05	1.08	1.08	0.29	0.52	0.83	1.01	0.70
12500	0.51	0.96	1.00	1.00	0.25	0.44	0.72	0.90	0.62
13000	0.46	0.88	0.92	0.92	0.21	0.38	0.62	0.82	0.55
13500	0.41	0.80	0.86	0.86	0.18	0.33	0.55	0.74	0.49
14000	0.37	0.74	0.80	0.80	0.16	0.28	0.48	0.66	0.44
14500	0.33	0.68	0.74	0.74	0.14	0.25	0.43	0.60	0.39
15000	0.30	0.62	0.69	0.69	0.13	0.22	0.37	0.54	0.36

Z250-19									
Span	Inward				Outward				Def 'n L/150
	0	1	2	3	0	1	2	3	
3000	13.89	13.89	13.89	13.89	13.89	13.89	13.89	13.89	58.20
3500	11.49	11.49	11.49	11.49	11.49	11.49	11.49	11.49	36.65
4000	9.69	9.69	9.69	9.69	9.69	9.69	9.69	9.69	24.55
4500	7.77	8.28	8.28	8.28	8.28	8.28	8.28	8.28	17.25
5000	5.94	7.16	7.16	7.16	7.16	7.16	7.16	7.16	12.57
5500	4.65	6.25	6.25	6.25	6.25	6.25	6.25	6.25	9.45
6000	3.73	5.49	5.49	5.49	4.87	5.49	5.49	5.49	7.28
6500	3.05	4.86	4.86	4.86	3.74	4.86	4.86	4.86	5.72
7000	2.54	4.34	4.34	4.34	2.84	4.24	4.34	4.34	4.58
7500	2.13	3.88	3.88	3.88	2.18	3.50	3.88	3.88	3.73
8000	1.82	3.45	3.45	3.45	1.71	2.92	3.45	3.45	3.07
8500	1.56	3.05	3.05	3.05	1.36	2.43	3.05	3.05	2.56
9000	1.35	2.73	2.73	2.73	1.10	2.02	2.64	2.73	2.16
9500	1.18	2.45	2.45	2.45	0.89	1.65	2.28	2.45	1.83
10000	1.04	2.21	2.21	2.21	0.74	1.35	1.98	2.21	1.57
10500	0.91	2.00	2.00	2.00	0.62	1.12	1.72	2.00	1.36
11000	0.81	1.81	1.82	1.82	0.52	0.93	1.50	1.81	1.18
11500	0.72	1.64	1.67	1.67	0.44	0.79	1.31	1.61	1.03
12000	0.65	1.48	1.53	1.53	0.38	0.67	1.14	1.43	0.91
12500	0.58	1.34	1.41	1.41	0.32	0.57	0.98	1.28	0.81
13000	0.52	1.22	1.31	1.31	0.28	0.49	0.84	1.14	0.72
13500	0.47	1.11	1.21	1.21	0.24	0.42	0.72	1.03	0.64
14000	0.43	1.02	1.13	1.13	0.21	0.37	0.63	0.92	0.57
14500	0.39	0.93	1.05	1.05	0.19	0.32	0.55	0.83	0.52
15000	0.35	0.85	0.98	0.98	0.17	0.28	0.48	0.74	0.47

Z250-24									
Span	Inward				Outward				Def 'n L/150
	0	1	2	3	0	1	2	3	
3000	18.01	18.01	18.01	18.01	18.01	18.01	18.01	18.01	75.31
3500	15.44	15.44	15.44	15.44	15.44	15.44	15.44	15.44	47.43
4000	12.06	13.51	13.51	13.51	13.51	13.51	13.51	13.51	31.77
4500	8.75	12.00	12.01	12.01	12.01	12.01	12.01	12.01	22.31
5000	6.62	10.81	10.81	10.81	10.81	10.81	10.81	10.81	16.27
5500	5.17	9.82	9.82	9.82	8.46	9.82	9.82	9.82	12.22
6000	4.15	8.57	8.57	8.57	6.38	8.57	8.57	8.57	9.41
6500	3.39	7.30	7.30	7.30	4.76	7.03	7.30	7.30	7.40
7000	2.82	6.29	6.29	6.29	3.60	5.77	6.29	6.29	5.93
7500	2.38	5.48	5.48	5.48	2.78	4.76	5.48	5.48	4.82
8000	2.03	4.77	4.82	4.82	2.18	3.94	4.82	4.82	3.97
8500	1.75	4.18	4.27	4.27	1.74	3.22	4.16	4.27	3.31
9000	1.52	3.70	3.81	3.81	1.41	2.61	3.59	3.81	2.79
9500	1.33	3.28	3.42	3.42	1.16	2.12	3.10	3.42	2.37
10000	1.17	2.93	3.08	3.08	0.96	1.74	2.69	3.08	2.03
10500	1.04	2.62	2.80	2.80	0.80	1.44	2.33	2.76	1.76
11000	0.93	2.36	2.55	2.55	0.68	1.21	2.01	2.46	1.53
11500	0.83	2.14	2.33	2.33	0.58	1.02	1.72	2.18	1.34
12000	0.74	1.94	2.14	2.14	0.50	0.87	1.47	1.95	1.18
12500	0.67	1.76	1.97	1.97	0.43	0.74	1.26	1.74	1.04
13000	0.61	1.61	1.83	1.83	0.37	0.64	1.08	1.55	0.93
13500	0.55	1.47	1.69	1.69	0.33	0.55	0.93	1.39	0.83
14000	0.50	1.34	1.56	1.57	0.29	0.48	0.81	1.23	0.74
14500	0.46	1.23	1.45	1.47	0.26	0.42	0.71	1.09	0.67
15000	0.42	1.13	1.34	1.37	0.23	0.37	0.62	0.96	0.60

**NOTE:** Bolting of section sizes from 100 to 250mm inclusive requires M12 grade 4.6 bolts. 300mm and 350mm sections require M16 grade 4.6 bolts. Shaded values require grade 8.8 bolts.

# DESIGN CAPACITY TABLES

Four lapped spans are continuous over four bays, supported at each end of the purlin and lapped over three internal supports.

(Tables in kN/m)

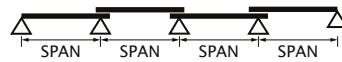

# 4 LAPPED

Z300-19									
Span	Inward				Outward				Def 'n L/150
	0	1	2	3	0	1	2	3	
3000	12.22	12.22	12.22	12.23	12.22	12.22	12.22	12.22	101.82
3500	10.30	10.30	10.30	10.30	10.30	10.30	10.30	10.30	64.12
4000	8.86	8.86	8.86	8.86	8.86	8.86	8.86	8.80	42.95
4500	7.72	7.72	7.72	7.72	7.72	7.72	7.72	7.72	30.17
5000	6.81	6.81	6.81	6.81	6.81	6.81	6.81	6.81	21.99
5500	6.05	6.05	6.05	6.05	6.05	6.05	6.05	6.05	16.52
6000	5.27	5.43	5.43	5.43	5.42	5.43	5.43	5.46	12.73
6500	4.30	4.89	4.89	4.89	4.89	4.89	4.89	4.89	10.01
7000	3.58	4.43	4.43	4.43	4.43	4.43	4.43	4.43	8.02
7500	3.03	4.03	4.03	4.03	4.03	4.03	4.03	4.03	6.52
8000	2.60	3.68	3.68	3.68	3.62	3.68	3.68	3.68	5.37
8500	2.23	3.38	3.38	3.38	2.92	3.38	3.38	3.38	4.48
9000	1.93	3.11	3.11	3.11	2.39	3.11	3.11	3.11	3.77
9500	1.69	2.87	2.87	2.87	1.98	2.87	2.87	2.87	3.21
10000	1.48	2.66	2.66	2.66	1.67	2.61	2.66	2.66	2.75
10500	1.31	2.46	2.46	2.46	1.39	2.29	2.46	2.46	2.38
11000	1.17	2.29	2.29	2.29	1.17	2.00	2.29	2.29	2.07
11500	1.05	2.14	2.14	2.14	0.99	1.72	2.14	2.14	1.81
12000	0.94	2.00	2.00	2.00	0.84	1.48	1.94	2.00	1.59
12500	0.85	1.83	1.86	1.86	0.72	1.28	1.74	1.86	1.41
13000	0.77	1.68	1.74	1.74	0.62	1.11	1.58	1.74	1.25
13500	0.70	1.55	1.63	1.63	0.54	0.97	1.43	1.61	1.12
14000	0.64	1.43	1.52	1.52	0.47	0.86	1.29	1.48	1.00
14500	0.58	1.32	1.42	1.42	0.41	0.76	1.17	1.35	0.90
15000	0.53	1.23	1.32	1.32	0.36	0.66	1.05	1.25	0.82

Z300-24									
Span	Inward				Outward				Def 'n L/150
	0	1	2	3	0	1	2	3	
3000	23.72	23.72	23.72	23.72	23.72	23.72	23.72	23.72	132.77
3500	19.74	19.74	19.74	19.74	19.74	19.74	19.74	19.74	83.61
4000	16.73	16.73	16.73	16.73	16.73	16.73	16.73	16.73	56.01
4500	13.87	14.41	14.41	14.41	14.41	14.41	14.41	14.41	39.34
5000	10.31	12.53	12.53	12.53	12.54	12.54	12.54	12.54	28.68
5500	7.86	11.00	11.00	11.00	11.00	11.00	11.00	11.00	21.55
6000	6.17	9.73	9.73	9.73	9.73	9.73	9.73	9.73	16.60
6500	4.97	8.66	8.66	8.66	8.66	8.66	8.66	8.66	13.05
7000	4.08	7.75	7.75	7.75	7.19	7.75	7.75	7.75	10.45
7500	3.40	6.98	6.98	6.98	5.85	6.98	6.98	6.98	8.50
8000	2.88	6.31	6.31	6.31	4.78	6.31	6.31	6.31	7.00
8500	2.47	5.73	5.73	5.73	3.89	5.60	5.73	5.73	5.84
9000	2.14	5.16	5.16	5.16	3.17	4.80	5.16	5.16	4.92
9500	1.87	4.60	4.63	4.63	2.58	4.13	4.63	4.63	4.18
10000	1.64	4.09	4.18	4.18	2.12	3.55	4.18	4.18	3.59
10500	1.45	3.66	3.79	3.79	1.77	3.06	3.79	3.79	3.10
11000	1.30	3.30	3.46	3.46	1.48	2.65	3.42	3.46	2.69
11500	1.16	2.98	3.16	3.16	1.25	2.30	3.04	3.16	2.36
12000	1.05	2.71	2.90	2.90	1.07	1.99	2.71	2.90	2.08
12500	0.95	2.46	2.68	2.68	0.92	1.72	2.42	2.68	1.84
13000	0.86	2.25	2.47	2.47	0.79	1.48	2.16	2.47	1.63
13500	0.78	2.07	2.29	2.29	0.69	1.28	1.93	2.29	1.46
14000	0.71	1.90	2.13	2.13	0.60	1.11	1.73	2.10	1.31
14500	0.66	1.75	1.99	1.99	0.53	0.97	1.55	1.92	1.18
15000	0.60	1.62	1.86	1.86	0.47	0.85	1.40	1.75	1.06

Z300-30									
Span	Inward				Outward				Def 'n L/150
	0	1	2	3	0	1	2	3	
4000	24.35	25.53	25.53	25.53	25.53	25.53	25.53	25.53	72.38
4500	16.85	22.69	22.69	22.69	22.69	22.69	22.69	22.69	50.84
5000	12.25	20.43	20.43	20.43	20.43	20.43	20.43	20.43	37.06
5500	9.26	18.27	18.27	18.27	18.27	18.27	18.27	18.27	27.84
6000	7.23	15.91	15.91	15.91	15.40	15.91	15.91	15.91	21.45
6500	5.79	13.89	13.89	13.89	12.48	13.89	13.89	13.89	16.87
7000	4.73	12.15	12.15	12.15	10.13	12.15	12.15	12.15	13.51
7500	3.94	10.46	10.58	10.58	8.12	10.51	10.58	10.58	10.98
8000	3.32	9.06	9.30	9.30	6.47	9.02	9.30	9.30	9.05
8500	2.84	7.91	8.24	8.24	5.15	7.78	8.23	8.23	7.54
9000	2.46	6.96	7.35	7.35	4.15	6.74	7.35	7.35	6.36
9500	2.14	6.16	6.59	6.59	3.38	5.82	6.59	6.59	5.40
10000	1.89	5.49	5.95	5.95	2.79	5.04	5.93	5.95	4.63
10500	1.67	4.90	5.40	5.40	2.33	4.34	5.28	5.40	4.00
11000	1.49	4.40	4.92	4.92	1.96	3.71	4.72	4.92	3.48
11500	1.34	3.96	4.50	4.50	1.66	3.16	4.23	4.50	3.05
12000	1.20	3.59	4.11	4.13	1.42	2.69	3.81	4.13	2.68
12500	1.09	3.26	3.76	3.81	1.22	2.30	3.41	3.81	2.37
13000	0.99	2.97	3.45	3.52	1.06	1.97	3.06	3.48	2.11
13500	0.90	2.72	3.17	3.27	0.92	1.71	2.75	3.18	1.88
14000	0.83	2.49	2.93	3.04	0.81	1.49	2.45	2.91	1.69
14500	0.76	2.29	2.71	2.83	0.71	1.30	2.18	2.67	1.52
15000	0.70	2.10	2.51	2.65	0.63	1.14	1.94	2.45	1.37
15500	0.65	1.94	2.33	2.48	0.56	1.01	1.72	2.25	1.24
16000	0.60	1.79	2.18	2.32	0.50	0.89	1.52	2.06	1.13
16500	0.56	1.66	2.03	2.16	0.45	0.80	1.35	1.89	1.03
17000	0.52	1.54	1.90	2.03	0.41	0.71	1.20	1.74	0.94
17500	0.48	1.43	1.78	1.90	0.37	0.64	1.08	1.59	0.86
18000	0.45	1.33	1.67	1.79	0.33	0.57	0.96	1.45	0.79

**NOTE:** Bolting of section sizes from 100 to 250mm inclusive requires M12 grade 4.6 bolts. 300mm and 350mm sections require M16 grade 4.6 bolts. Shaded values require grade 8.8 bolts.

# 4 LAPPED

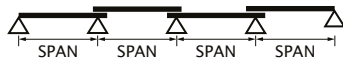

## DESIGN CAPACITY TABLES

Four lapped spans are continuous over four bays, supported at each end of the purlin and lapped over three internal supports.

(Tables in kN/m)

Z350-19									
Span	Inward				Outward				Def 'n L/150
	0	1	2	3	0	1	2	3	
2000	16.20	16.20	16.20	16.20	16.20	16.20	16.20	16.20	560.49
2500	12.89	12.89	12.89	12.89	12.89	12.89	12.89	12.89	286.97
3000	10.68	10.68	10.68	10.68	10.68	10.68	10.68	10.68	166.08
3500	9.07	9.07	9.07	9.07	9.07	9.07	9.07	9.07	104.58
4000	7.88	7.88	7.88	7.88	7.88	7.88	7.88	7.88	70.06
4500	6.93	6.93	6.93	6.93	6.93	6.93	6.93	6.93	49.21
5000	6.18	6.18	6.18	6.18	6.18	6.18	6.18	6.18	35.87
5500	5.55	5.55	5.55	5.55	5.55	5.55	5.55	5.55	26.95
6000	5.03	5.03	5.03	5.03	5.03	5.03	5.03	5.03	20.76
6500	4.58	4.58	4.58	4.58	4.58	4.58	4.58	4.58	16.33
7000	4.20	4.20	4.20	4.20	4.20	4.20	4.20	4.20	13.07
7500	3.86	3.86	3.86	3.86	3.86	3.86	3.86	3.86	10.63
8000	3.51	3.57	3.57	3.57	3.57	3.57	3.57	3.57	8.76
8500	3.00	3.31	3.31	3.31	3.31	3.31	3.31	3.31	7.30
9000	2.59	3.08	3.08	3.08	3.08	3.08	3.08	3.08	6.15
9500	2.26	2.87	2.87	2.87	2.87	2.87	2.87	2.87	5.23
10000	1.98	2.68	2.68	2.68	2.68	2.68	2.68	2.68	4.48
10500	1.75	2.51	2.51	2.51	2.51	2.51	2.51	2.51	3.87
11000	1.56	2.36	2.36	2.36	2.25	2.36	2.36	2.36	3.37
11500	1.40	2.22	2.22	2.22	1.96	2.22	2.22	2.22	2.95
12000	1.26	2.09	2.09	2.09	1.68	2.09	2.09	2.09	2.60
12500	1.14	1.97	1.97	1.97	1.45	1.97	1.97	1.97	2.30
13000	1.03	1.87	1.87	1.86	1.26	1.87	1.87	1.87	2.04
13500	0.94	1.76	1.76	1.76	1.10	1.75	1.76	1.76	1.82
14000	0.86	1.67	1.67	1.67	0.97	1.58	1.67	1.67	1.63
14500	0.79	1.59	1.59	1.59	0.85	1.42	1.59	1.59	1.47
15000	0.73	1.51	1.51	1.51	0.75	1.27	1.51	1.51	1.33

Z350-24									
Span	Inward				Outward				Def 'n L/150
	0	1	2	3	0	1	2	3	
3000	21.15	21.15	21.15	21.15	21.15	21.15	21.15	21.15	216.58
3500	17.85	17.85	17.85	17.85	17.85	17.85	17.85	17.85	136.39
4000	15.39	15.39	15.39	15.39	15.39	15.39	15.39	15.39	91.37
4500	13.43	13.43	13.43	13.43	13.43	13.43	13.43	13.43	64.17
5000	11.88	11.88	11.86	11.88	11.88	11.88	11.88	11.88	46.78
5500	10.58	10.58	10.58	10.58	10.58	10.58	10.58	10.58	35.15
6000	9.28	9.50	9.50	9.50	9.50	9.50	9.50	9.50	27.07
6500	7.40	8.57	8.57	8.57	8.57	8.57	8.57	8.57	21.29
7000	6.07	7.79	7.79	7.79	7.79	7.79	7.79	7.79	17.05
7500	5.04	7.10	7.10	7.10	7.10	7.10	7.10	7.10	13.86
8000	4.21	6.50	6.50	6.50	6.50	6.50	6.50	6.50	11.42
8500	3.56	5.97	5.97	5.97	5.97	5.97	5.97	5.97	9.52
9000	3.04	5.51	5.51	5.51	5.51	5.51	5.51	5.51	8.02
9500	2.63	5.09	5.09	5.09	4.99	5.09	5.09	5.09	6.82
10000	2.30	4.72	4.72	4.72	4.20	4.72	4.72	4.72	5.85
10500	2.02	4.39	4.39	4.39	3.54	4.39	4.39	4.39	5.05
11000	1.79	4.09	4.08	4.09	3.00	4.09	4.08	4.09	4.39
11500	1.60	3.81	3.81	3.81	2.57	3.81	3.81	3.81	3.85
12000	1.43	3.57	3.57	3.57	2.21	3.47	3.57	3.57	3.38
12500	1.29	3.32	3.34	3.34	1.93	3.12	3.34	3.34	2.99
13000	1.17	3.04	3.14	3.14	1.69	2.81	3.14	3.14	2.66
13500	1.07	2.80	2.94	2.94	1.46	2.51	2.94	2.94	2.38
14000	0.97	2.58	2.76	2.76	1.28	2.23	2.76	2.76	2.13
14500	0.89	2.39	2.60	2.60	1.12	1.97	2.50	2.60	1.92
15000	0.82	2.21	2.43	2.43	0.98	1.75	2.30	2.43	1.73
15500	0.76	2.06	2.28	2.28	0.87	1.55	2.12	2.28	1.57
16000	0.70	1.91	2.14	2.14	0.77	1.39	1.96	2.14	1.43
16500	0.65	1.79	2.00	2.01	0.69	1.24	1.81	2.01	1.30
17000	0.60	1.67	1.88	1.89	0.61	1.12	1.67	1.87	1.19
17500	0.56	1.56	1.76	1.79	0.55	1.01	1.55	1.75	1.09
18000	0.52	1.47	1.66	1.69	0.50	0.92	1.42	1.64	1.00

Z350-30									
Span	Inward				Outward				Def 'n L/150
	0	1	2	3	0	1	2	3	
4000	25.53	25.53	25.53	25.53	25.53	25.53	25.53	25.53	117.79
4500	22.69	22.69	22.69	22.69	22.69	22.69	22.69	22.69	82.71
5000	19.73	20.43	20.43	20.43	20.43	20.43	20.43	20.43	60.30
5500	14.78	18.57	18.57	18.57	18.57	18.57	18.57	18.57	45.31
6000	11.27	16.79	16.79	16.76	16.79	16.79	16.79	16.79	34.90
6500	8.81	14.99	14.99	14.99	14.99	14.99	14.99	14.99	27.45
7000	7.06	13.47	13.47	13.47	13.47	13.47	13.47	13.47	21.98
7500	5.77	12.15	12.15	12.15	12.15	12.15	12.15	12.15	17.87
8000	4.79	11.01	11.01	11.01	10.62	11.01	11.01	11.01	14.72
8500	4.04	10.02	10.02	10.02	8.95	10.02	10.02	10.02	12.27
9000	3.45	9.16	9.16	9.16	7.55	9.16	9.16	9.16	10.34
9500	2.98	8.32	8.38	8.38	6.36	8.38	8.38	8.38	8.79
10000	2.59	7.38	7.56	7.56	5.41	7.49	7.56	7.56	7.54
10500	2.28	6.57	6.86	6.86	4.62	6.61	6.86	6.86	6.51
11000	2.02	5.89	6.25	6.25	3.94	5.85	6.25	6.25	5.66
11500	1.80	5.29	5.72	5.72	3.37	5.19	5.72	5.72	4.96
12000	1.61	4.78	5.25	5.25	2.87	4.61	5.25	5.25	4.36
12500	1.45	4.33	4.84	4.84	2.46	4.09	4.84	4.84	3.86
13000	1.32	3.94	4.48	4.47	2.12	3.64	4.48	4.48	3.43
13500	1.20	3.59	4.15	4.15	1.84	3.23	4.10	4.15	3.06
14000	1.09	3.28	3.86	3.86	1.60	2.87	3.73	3.86	2.75
14500	1.00	3.01	3.60	3.60	1.41	2.56	3.41	3.60	2.47
15000	0.92	2.77	3.36	3.36	1.24	2.29	3.11	3.36	2.23
15500	0.85	2.55	3.13	3.15	1.10	2.06	2.85	3.15	2.02
16000	0.79	2.36	2.91	2.95	0.97	1.84	2.60	2.95	1.84
16500	0.73	2.19	2.71	2.78	0.87	1.65	2.38	2.78	1.68
17000	0.68	2.03	2.53	2.62	0.78	1.47	2.18	2.59	1.53
17500	0.63	1.89	2.36	2.47	0.70	1.31	2.00	2.41	1.41
18000	0.59	1.76	2.21	2.33	0.63	1.18	1.83	2.24	1.29

**NOTE:**

Bolting of section sizes from 100 to 250mm inclusive requires M12 grade 4.6 bolts.

300mm and 350mm sections require M16 grade 4.6 bolts.

Shaded values require grade 8.8 bolts.

# DESIGN CAPACITY TABLES

Cantilever spans have the purlin cantilevered past the end frame of the building.

(Tables in kN/m)



# 1000 CANTILEVER

1000mm									
Span	Inward				Outward				Def 'n L/150
	0	1	2	3	0	1	2	3	
<b>C/Z150-10</b>									
3000	3.54	3.54	3.54	3.54	3.54	3.54	3.54	3.54	2.48
4500	1.86	1.86	1.86	1.86	1.26	1.84	1.86	1.86	0.42
6000	1.00	1.00	1.00	1.00	0.42	0.80	0.99	1.00	0.16
<b>C/Z150-15</b>									
3000	7.45	7.55	7.55	7.55	7.47	7.55	7.55	7.55	3.94
4500	2.80	2.94	2.94	2.94	2.12	2.87	2.93	2.93	0.67
6000	1.47	1.58	1.58	1.58	0.68	1.30	1.55	1.58	0.25
<b>C/Z150-24</b>									
3000	11.95	14.23	14.23	14.23	12.90	14.22	14.23	14.23	6.37
4500	4.31	5.45	5.53	5.53	3.53	4.98	5.53	5.53	1.09
6000	2.21	2.81	2.97	2.97	1.19	2.18	2.69	2.94	0.40
7500	1.34	1.72	1.81	1.86	0.53	1.01	1.46	1.70	0.20
9000	0.90	1.16	1.21	1.26	0.28	0.51	0.83	1.05	0.11
<b>C/Z200-15</b>									
3000	8.69	8.69	8.69	8.69	8.69	8.69	8.69	8.69	8.40
4500	4.15	4.17	4.17	4.17	3.77	4.17	4.17	4.17	1.44
6000	2.18	2.24	2.24	2.24	1.39	2.20	2.24	2.24	0.53
7500	1.34	1.41	1.41	1.41	0.60	1.13	1.41	1.41	0.26
9000	0.90	0.97	0.97	0.97	0.29	0.59	0.88	0.97	0.15
<b>C/Z200-24</b>									
3000	18.66	18.66	18.66	18.66	18.66	18.66	18.66	18.66	14.18
4500	7.06	8.50	8.48	8.48	7.12	8.50	8.48	8.48	2.43
6000	3.48	4.56	4.56	4.56	2.53	4.18	4.56	4.56	0.90
7500	2.05	2.79	2.86	2.86	1.07	2.15	2.73	2.86	0.44
9000	1.34	1.87	1.96	1.96	0.54	1.09	1.67	1.92	0.25
10500	0.94	1.34	1.41	1.43	0.31	0.60	1.02	1.30	0.15
<b>C/Z250-19</b>									
3000	14.23	14.23	14.23	14.23	14.23	14.23	14.23	14.23	18.56
4500	7.12	7.66	7.66	7.66	6.95	7.66	7.66	7.66	3.18
6000	3.62	4.12	4.12	4.12	2.60	4.06	4.12	4.12	1.18
7500	2.18	2.58	2.58	2.58	1.07	2.13	2.58	2.58	0.57
9000	1.45	1.77	1.77	1.77	0.53	1.12	1.62	1.77	0.32
10500	1.04	1.29	1.29	1.29	0.29	0.61	1.02	1.26	0.20
12000	0.77	0.99	0.99	0.99	0.18	0.36	0.63	0.87	0.13
<b>C/Z300-19</b>									
6000	4.96	5.56	5.56	5.56	4.93	5.56	5.56	5.56	2.07
7500	2.96	3.48	3.48	3.48	2.39	3.40	3.48	3.48	1.01
9000	1.96	2.39	2.39	2.39	1.22	2.12	2.39	2.39	0.57
10500	1.37	1.74	1.75	1.75	0.67	1.34	1.68	1.75	0.35
12000	1.00	1.31	1.33	1.33	0.40	0.83	1.19	1.33	0.23
13500	0.77	1.02	1.05	1.05	0.25	0.53	0.86	1.00	0.16
15000	0.60	0.81	0.85	0.85	0.17	0.35	0.59	0.77	0.12
<b>C/Z300-30</b>									
6000	8.13	11.11	11.11	11.11	9.47	11.11	11.11	11.11	3.48
7500	4.33	6.95	6.96	6.96	4.22	6.69	6.96	6.96	1.69
9000	2.65	4.58	4.78	4.78	2.07	4.11	4.78	4.78	0.95
10500	1.78	3.22	3.49	3.49	1.15	2.44	3.30	3.49	0.59
12000	1.28	2.36	2.61	2.66	0.69	1.45	2.31	2.63	0.39
13500	0.96	1.79	2.00	2.10	0.45	0.92	1.58	1.97	0.27
15000	0.75	1.40	1.58	1.68	0.31	0.61	1.06	1.49	0.20
<b>C/Z350-24</b>									
6000	9.13	10.14	10.14	10.14	10.06	10.15	10.15	10.15	4.37
7500	5.21	6.36	6.36	6.36	5.70	6.36	6.36	6.36	2.12
9000	3.19	4.37	4.37	4.37	3.19	4.34	4.37	4.37	1.20
10500	2.13	3.17	3.19	3.19	1.83	2.98	3.19	3.19	0.74
12000	1.52	2.35	2.43	2.43	1.12	2.09	2.42	2.43	0.49
13500	1.14	1.81	1.91	1.91	0.71	1.41	1.83	1.91	0.34
15000	0.88	1.43	1.55	1.55	0.47	0.96	1.40	1.55	0.25

1000mm									
Span	Inward				Outward				Def 'n L/150
	0	1	2	3	0	1	2	3	
<b>C/Z150-12</b>									
3000	5.83	5.83	5.83	5.83	5.83	5.83	5.83	5.83	3.09
4500	2.30	2.30	2.30	2.30	1.60	2.30	2.30	2.30	0.53
6000	1.24	1.24	1.24	1.24	0.53	1.01	1.24	1.24	0.20
<b>C/Z150-19</b>									
3000	9.90	10.47	10.47	10.47	10.29	10.47	10.48	10.48	5.06
4500	3.64	4.08	4.08	4.08	2.75	3.96	4.07	4.07	0.87
6000	1.89	2.19	2.19	2.19	0.89	1.71	2.14	2.19	0.32
7500	1.15	1.37	1.37	1.37	0.39	0.77	1.16	1.35	0.16
<b>C/Z200-12</b>									
3000	4.62	4.62	4.62	4.62	4.62	4.62	4.62	4.62	6.43
4500	3.14	3.18	3.18	3.18	2.77	3.18	3.18	3.18	1.10
6000	1.65	1.71	1.71	1.71	1.06	1.59	1.71	1.71	0.41
7500	1.02	1.07	1.07	1.07	0.46	0.84	1.04	1.07	0.20
9000	0.69	0.74	0.74	0.74	0.23	0.45	0.64	0.73	0.11
<b>C/Z200-19</b>									
3000	14.77	14.77	14.77	14.77	14.77	14.77	14.77	14.77	11.10
4500	5.46	6.12	6.12	6.12	5.27	6.12	6.12	6.12	1.90
6000	2.81	3.29	3.29	3.29	1.97	3.05	3.29	3.29	0.71
7500	1.71	2.06	2.06	2.06	0.82	1.64	1.99	2.06	0.34
9000	1.15	1.42	1.42	1.42	0.41	0.85	1.23	1.41	0.19
<b>C/Z250-15</b>									
3000	7.19	7.19	7.19	7.19	7.19	7.19	7.19	7.20	14.20
4500	5.16	5.16	5.16	5.16	4.93	5.16	5.16	5.16	2.43
6000	2.72	2.91	2.91	2.91	1.95	2.81	2.91	2.91	0.90
7500	1.67	1.82	1.82	1.82	0.83	1.54	1.81	1.81	0.44
9000	1.13	1.25	1.25	1.25	0.40	0.83	1.14	1.25	0.25
10500	0.81	0.91	0.91	0.91	0.22	0.47	0.74	0.87	0.15
<b>C/Z250-24</b>									
3000	14.24	14.24	14.24	14.25	14.24	14.24	14.24	14.24	18.56
4500	7.15	7.71	7.71	7.71	6.99	7.71	7.71	7.71	3.18
6000	3.65	4.14	4.14	4.14	2.59	4.08	4.14	4.14	1.18
7500	2.20	2.59	2.59	2.59	1.07	2.15	2.59	2.59	0.57
9000	1.47	1.78	1.78	1.78	0.53	1.11	1.63	1.78	0.32
10500	1.05	1.30	1.30	1.30	0.29	0.60	1.03	1.27	0.20
12000	0.78	0.99	0.99	0.99	0.18	0.36	0.63	0.87	0.13
<b>C/Z300-24</b>									
6000	6.34	7.81	7.81	7.81	6.71	7.81	7.81	7.81	2.70
7500	3.64	4.89	4.89	4.89	3.19	4.84	4.89	4.89	1.31
9000	2.33	3.36	3.36	3.36	1.56	2.90	3.36	3.36	0.74
10500	1.60	2.42	2.45	2.45	0.86	1.79	2.37	2.45	0.46
12000	1.16	1.78	1.87	1.87	0.51	1.09	1.63	1.87	0.30
13500	0.88	1.37	1.47	1.47	0.33	0.68	1.14	1.42	0.21
15000	0.68	1.08	1.19	1.19	0.22	0.45	0.80	1.06	0.15
<b>C/Z350-19</b>									
6000	5.74	5.74	5.74	5.74	5.74	5.74	5.74	5.74	3.36
7500	3.87	4.51	4.51	4.51	3.99	4.51	4.51	4.51	1.63
9000	2.52	3.10	3.10	3.10	2.34	3.04	3.10	3.10	0.92
10500	1.75	2.25	2.26	2.26	1.39	2.08	2.26	2.26	0.57
12000	1.28	1.68	1.72	1.72	0.85	1.46	1.70	1.72	0.38
13500	0.97	1.30	1.36	1.36	0.55	1.03	1.28	1.36	0.26
15000	0.76	1.04	1.10	1.10	0.37	0.74	0.98	1.09	0.19
<b>C/Z350-30</b>									
6000	11.68	14.01	14.01	14.01	10.15	14.01	14.01	14.01	5.65
7500	6.33	8.85	8.85	8.85	7.56	8.85	8.85	8.85	2.74
9000	3.86	6.08	6.08	6.08	4.21	6.08	6.08	6.08	1.55
10500	2.54	4.32	4.44	4.44	2.41	4.04	4.44	4.44	0.96
12000	1.77	3.14	3.38	3.38	1.43	2.73	3.38	3.38	0.64
13500	1.30	2.37	2.66	2.66	0.91	1.86	2.51	2.66	0.44
15000	1.00	1.83	2.12	2.15	0.61	1.29	1.87	2.15	0.32

**NOTE:** Bolting of section sizes from 100 to 250mm inclusive requires M12 grade 4.6 bolts. 300mm and 350mm sections require M16 grade 4.6 bolts. Shaded values require grade 8.8 bolts.

# 2000 CANTILEVER



# DESIGN CAPACITY TABLES

Cantilever spans have the purlin cantilevered past the end frame of the building.

(Tables in kN/m)

2000mm									
Span	Inward				Outward				Def 'n L/150
	0	1	2	3	0	1	2	3	
C/Z150-10									
3000	1.91	1.91	1.91	1.91	1.91	1.91	1.91	1.91	0.66
4500	1.72	1.72	1.72	1.72	1.72	1.72	1.72	1.72	1.98
6000	1.18	1.20	1.20	1.20	0.53	0.97	1.20	1.20	0.31
7500	0.70	0.70	0.70	0.70	0.21	0.40	0.60	0.70	0.11
C/Z150-15									
3000	3.36	3.36	3.36	3.36	3.36	3.36	3.36	3.36	1.05
4500	3.09	3.36	3.36	3.36	2.88	3.36	3.36	3.36	3.15
6000	1.68	1.89	1.89	1.89	0.85	1.57	1.86	1.89	0.49
7500	0.98	1.11	1.11	1.11	0.33	0.66	0.96	1.10	0.17
C/Z150-24									
3000	6.27	6.32	6.32	6.32	6.32	6.32	6.32	6.32	1.70
4500	4.74	6.32	6.32	6.32	4.84	6.01	6.32	6.32	5.09
6000	2.43	3.34	3.56	3.56	1.48	2.63	3.23	3.53	0.80
7500	1.42	1.91	2.02	2.09	0.61	1.14	1.64	1.91	0.28
9000	0.93	1.24	1.31	1.36	0.31	0.55	0.90	1.14	0.14
C/Z200-15									
3000	4.44	4.44	4.44	4.44	4.44	4.44	4.44	4.44	2.24
4500	4.04	4.04	4.04	4.04	4.04	4.04	4.04	4.04	6.71
6000	2.47	2.68	2.69	2.69	1.72	2.64	2.69	2.69	1.05
7500	1.44	1.57	1.57	1.57	0.69	1.27	1.57	1.57	0.36
9000	0.94	1.05	1.04	1.04	0.32	0.64	0.95	1.04	0.18
C/Z200-24									
3000	9.69	9.69	9.69	9.69	9.69	9.69	9.69	9.69	3.78
4500	7.72	9.69	9.69	9.69	9.05	9.69	9.69	9.69	11.32
6000	3.74	5.44	5.45	5.45	3.14	5.02	5.45	5.45	1.77
7500	2.12	3.11	3.19	3.20	1.22	2.41	3.05	3.20	0.61
9000	1.36	2.02	2.12	2.12	0.59	1.18	1.81	2.07	0.30
10500	0.95	1.41	1.49	1.51	0.33	0.64	1.08	1.38	0.18
C/Z250-19									
3000	7.74	7.74	7.74	7.74	7.74	7.74	7.74	7.74	4.95
4500	6.95	6.95	6.95	6.95	6.95	6.95	6.95	6.95	14.83
6000	4.03	4.93	4.93	4.93	3.24	4.88	4.93	4.93	2.32
7500	2.32	2.89	2.89	2.89	1.22	2.39	2.89	2.89	0.80
9000	1.51	1.92	1.92	1.92	0.58	1.20	1.75	1.92	0.40
10500	1.06	1.37	1.37	1.37	0.31	0.64	1.08	1.33	0.23
12000	0.79	1.03	1.03	1.03	0.19	0.37	0.66	0.91	0.15
C/Z300-19									
6000	5.63	5.68	5.68	5.68	5.68	5.68	5.68	5.68	4.08
7500	3.17	3.90	3.90	3.90	2.72	3.80	3.89	3.89	1.41
9000	2.01	2.59	2.58	2.58	1.33	2.30	2.58	2.58	0.70
10500	1.38	1.84	1.85	1.85	0.71	1.42	1.77	1.85	0.41
12000	1.01	1.36	1.39	1.39	0.42	0.86	1.24	1.39	0.26
13500	0.77	1.05	1.08	1.08	0.26	0.55	0.89	1.04	0.18
15000	0.60	0.83	0.87	0.87	0.17	0.36	0.61	0.79	0.13
C/Z300-30									
6000	8.40	13.28	13.28	13.28	11.57	13.28	13.45	13.45	6.85
7500	4.37	7.73	7.78	7.79	4.78	7.49	7.78	7.79	2.37
9000	2.66	4.93	5.16	5.16	2.25	4.44	5.16	5.16	1.17
10500	1.78	3.39	3.69	3.69	1.22	2.57	3.49	3.69	0.68
12000	1.27	2.45	2.73	2.78	0.73	1.51	2.41	2.75	0.44
13500	0.95	1.85	2.07	2.17	0.47	0.95	1.63	2.04	0.30
15000	0.74	1.43	1.62	1.73	0.32	0.63	1.09	1.53	0.21
C/Z350-24									
6000	9.87	9.87	9.87	9.87	9.87	9.87	9.87	9.87	8.59
7500	5.37	7.11	7.11	7.11	6.42	7.11	7.11	7.11	2.97
9000	3.22	4.71	4.71	4.71	3.46	4.69	4.71	4.71	1.47
10500	2.14	3.34	3.37	3.37	1.94	3.15	3.37	3.37	0.85
12000	1.52	2.45	2.54	2.54	1.17	2.18	2.53	2.54	0.55
13500	1.13	1.87	1.98	1.98	0.74	1.45	1.89	1.98	0.37
15000	0.88	1.47	1.59	1.59	0.49	0.99	1.44	1.59	0.27

2000mm									
Span	Inward				Outward				Def 'n L/150
	0	1	2	3	0	1	2	3	
C/Z150-12									
3000	2.63	2.63	2.63	2.63	2.63	2.63	2.63	2.63	0.83
4500	2.51	2.51	2.51	2.51	2.31	2.51	2.51	2.51	2.47
6000	1.47	1.48	1.48	1.48	0.67	1.23	1.48	1.48	0.39
7500	0.87	0.87	0.87	0.87	0.25	0.50	0.78	0.87	0.13
C/Z150-19									
3000	4.65	4.65	4.65	4.65	4.65	4.65	4.65	4.65	1.35
4500	3.99	4.65	4.65	4.65	3.84	4.65	4.65	4.65	4.04
6000	2.10	2.62	2.62	2.62	1.12	2.07	2.57	2.62	0.63
7500	1.23	1.54	1.54	1.54	0.44	0.86	1.30	1.51	0.22
C/Z200-12									
3000	2.78	2.78	2.78	2.78	2.78	2.78	2.78	2.78	1.72
4500	2.43	2.43	2.43	2.43	2.43	2.43	2.43	2.43	5.14
6000	1.91	2.05	2.05	2.05	1.33	1.92	2.05	2.05	0.80
7500	1.12	1.20	1.20	1.20	0.53	0.95	1.16	1.20	0.28
9000	0.74	0.80	0.80	0.80	0.25	0.49	0.69	0.79	0.14
C/Z200-19									
3000	7.00	7.00	7.00	7.00	7.00	7.00	7.00	7.00	2.96
4500	6.06	6.70	6.70	6.70	6.63	6.70	6.70	6.70	8.87
6000	3.19	3.94	3.94	3.94	2.46	3.67	3.94	3.94	1.39
7500	1.84	2.31	2.31	2.31	0.94	1.84	2.23	2.31	0.48
9000	1.20	1.53	1.53	1.53	0.45	0.91	1.33	1.52	0.24
C/Z250-15									
3000	4.47	4.47	4.47	4.47	4.466	4.47	4.47	4.47	3.79
4500	3.87	3.87	3.87	3.87	3.867	3.87	3.87	3.87	11.20
6000	3.12	3.30	3.30	3.30	2.425	3.30	3.30	3.30	1.78
7500	1.81	2.04	2.04	2.04	0.95	1.72	2.04	2.04	0.61
9000	1.19	1.36	1.36	1.36	0.443	0.90	1.24	1.35	0.30
10500	0.84	0.97	0.97	0.97	0.237	0.50	0.79	0.93	0.18
C/Z250-24									
3000	11.94	11.94	11.94	11.94	11.94	11.94	11.94	11.94	6.40
4500	9.98	10.60	10.60	10.60	10.60	10.60	10.60	10.60	19.18
6000	4.69	6.88	6.88	6.88	4.12	6.63	6.89	6.89	3.00
7500	2.64	4.04	4.04	4.04	1.57	3.20	4.02	4.04	1.04
9000	1.68	2.63	2.68	2.68	0.75	1.54	2.38	2.68	0.51
10500	1.17	1.84	1.91	1.91	0.41	0.83	1.43	1.81	0.30
12000	0.86	1.35	1.44	1.44	0.25	0.49	0.84	1.23	0.19
C/Z300-24									
6000	6.94	9.33	9.33	9.33	8.20	9.33	9.33	9.33	5.31
7500	3.789	5.47	5.47	5.47	3.63	5.42	5.47	5.47	1.83
9000	2.361	3.63	3.63	3.63	1.70	3.14	3.63	3.63	0.91
10500	1.603	2.54	2.59	2.59	0.91	1.89	2.51	2.59	0.53
12000	1.155	1.85	1.95	1.95	0.54	1.13	1.70	1.95	0.34
13500	0.871	1.41	1.52	1.52	0.34	0.71	1.17	1.47	0.23
15000	0.68	1.10	1.22	1.22	0.23	0.47	0.82	1.09	0.16
C/Z350-19									
6000	5.09	5.09	5.09	5.09	5.09	5.09	5.09	5.09	6.61
7500	4.16	4.28	4.28	4.28	4.28	4.28	4.28	4.28	2.28
9000	2.62	3.35	3.34	3.34	2.54	3.29	3.34	3.34	1.13
10500	1.78	2.38	2.39	2.39	1.48	2.20	2.39	2.39	0.66
12000	1.29	1.75	1.80	1.80	0.89	1.52	1.77	1.80	0.42
13500	0.98	1.34	1.40	1.40	0.57	1.06	1.32	1.40	0.29
15000	0.77	1.06	1.13	1.13	0.38	0.75	1.01	1.12	0.20
C/Z350-30									
6000	12.67	16.88	16.88	16.88	16.88	16.88	16.88	16.88	11.11
7500	6.58	9.90	9.90	9.90	8.53	9.90	9.90	9.90	3.84
9000	3.90	6.58	6.58	6.58	4.56	6.57	6.58	6.58	1.90
10500	2.52	4.55	4.69	4.69	2.55	4.27	4.69	4.69	1.11
12000	1.76	3.26	3.53	3.53	1.50	2.84	3.53	3.53	0.71
13500	1.29	2.43	2.76	2.76	0.94	1.92	2.59	2.76	0.48
15000	0.99	1.87	2.18	2.21	0.63	1.32	1.92	2.21	0.34

**NOTE:** Bolting of section sizes from 100 to 250mm inclusive requires M12 grade 4.6 bolts. 300mm and 350mm sections require M16 grade 4.6 bolts. Shaded values require grade 8.8 bolts.



# DESIGN CAPACITY TABLES

Cantilever spans have the purlin cantilevered past the end frame of the building.

(Tables in kN/m)



# 3000 CANTILEVER

3000mm									
Span	Inward				Outward				Def 'n L/150
	0	1	2	3	0	1	2	3	
<b>C/Z200-15</b>									
3000	2.12	2.12	2.12	2.12	2.12	2.12	2.12	2.12	0.62
4500	2.12	2.12	2.12	2.12	2.12	2.12	2.12	2.12	0.66
6000	2.07	2.12	2.12	2.12	2.08	2.12	2.12	2.12	1.24
7500	1.57	1.93	1.93	1.93	0.91	1.59	1.93	1.93	1.24
9000	1.01	1.19	1.19	1.19	0.39	0.74	1.09	1.19	0.31
<b>C/Z200-24</b>									
3000	4.31	4.31	4.31	4.31	4.31	4.31	4.31	4.31	1.05
4500	4.26	4.31	4.31	4.31	4.31	4.31	4.31	4.31	1.12
6000	3.49	4.31	4.31	4.31	3.92	4.31	4.31	4.31	2.10
7500	2.18	3.77	3.91	3.91	1.59	3.01	3.76	3.91	2.09
9000	1.39	2.29	2.42	2.42	0.70	1.38	2.08	2.37	0.53
10500	0.96	1.54	1.64	1.67	0.37	0.71	1.20	1.52	0.24
<b>C/Z250-19</b>									
3000	3.89	3.89	3.89	3.89	3.89	3.89	3.89	3.89	1.38
4500	3.89	3.89	3.89	3.89	3.89	3.89	3.89	3.89	1.47
6000	3.51	3.80	3.80	3.80	3.80	3.80	3.80	3.80	2.75
7500	2.47	3.53	3.53	3.53	1.60	2.97	3.53	3.53	2.74
9000	1.58	2.19	2.19	2.19	0.69	1.40	2.01	2.19	0.69
10500	1.10	1.51	1.51	1.51	0.35	0.71	1.20	1.47	0.32
12000	0.80	1.11	1.11	1.11	0.20	0.40	0.71	0.98	0.18
<b>C/Z300-19</b>									
3000	4.56	4.56	4.56	4.56	4.56	4.56	4.56	4.56	2.42
4500	4.40	4.40	4.40	4.40	4.40	4.40	4.40	4.40	2.58
6000	4.09	4.09	4.09	4.09	4.09	4.09	4.09	4.09	4.83
7500	3.38	3.75	3.75	3.75	3.50	3.75	3.75	3.75	4.82
9000	2.09	2.95	2.95	2.95	1.58	2.64	2.95	2.95	1.21
10500	1.42	2.01	2.03	2.03	0.80	1.57	1.96	2.03	0.56
12000	1.03	1.46	1.49	1.49	0.45	0.93	1.34	1.49	0.32
<b>C/Z300-30</b>									
3000	10.49	10.49	10.49	10.49	10.49	10.49	10.49	10.49	4.06
4500	10.49	10.49	10.49	10.49	10.49	10.49	10.49	10.49	4.33
6000	8.43	10.49	10.49	10.49	10.49	10.49	10.49	10.49	8.12
7500	4.54	9.37	9.53	9.53	6.16	9.23	9.43	9.53	8.04
9000	2.73	5.59	5.91	5.91	2.65	5.11	5.91	5.91	2.03
10500	1.81	3.71	4.06	4.07	1.37	2.85	3.85	4.07	0.94
12000	1.29	2.62	2.93	2.99	0.79	1.63	2.59	2.96	0.54
<b>C/Z350-24</b>									
6000	7.21	7.21	7.21	7.21	7.21	7.21	7.21	7.21	10.18
7500	5.71	6.60	6.60	6.60	6.60	6.60	6.60	6.60	10.16
9000	3.36	5.39	5.39	5.39	4.06	5.37	5.39	5.39	2.55
10500	2.20	3.66	3.71	3.71	2.17	3.47	3.71	3.71	1.18
12000	1.55	2.62	2.73	2.73	1.28	2.35	2.72	2.72	0.68
13500	1.15	1.97	2.09	2.09	0.79	1.54	2.00	2.09	0.44
15000	0.90	1.53	1.66	1.66	0.51	1.03	1.51	1.66	0.30

3000mm									
Span	Inward				Outward				Def 'n L/150
	0	1	2	3	0	1	2	3	
<b>C/Z200-12</b>									
3000	1.53	1.53	1.53	1.53	1.53	1.53	1.53	1.53	0.48
4500	1.49	1.49	1.49	1.49	1.49	1.49	1.49	1.49	0.51
6000	1.41	1.41	1.41	1.41	1.41	1.41	1.41	1.41	0.95
7500	1.27	1.31	1.31	1.31	0.70	1.18	1.31	1.31	0.95
9000	0.81	0.91	0.91	0.91	0.30	0.57	0.80	0.90	0.24
<b>C/Z200-19</b>									
3000	3.11	3.11	3.11	3.11	3.11	3.11	3.11	3.11	0.82
4500	3.11	3.11	3.11	3.11	3.11	3.11	3.11	3.11	0.88
6000	2.72	3.11	3.11	3.11	2.87	3.11	3.11	3.11	1.64
7500	1.98	2.83	2.83	2.83	1.23	2.28	2.75	2.82	1.64
9000	1.27	1.73	1.75	1.75	0.53	1.06	1.53	1.74	0.41
<b>C/Z250-15</b>									
3000	2.52	2.52	2.52	2.52	2.52	2.52	2.52	2.52	1.05
4500	2.44	2.44	2.44	2.44	2.44	2.44	2.44	2.44	1.12
6000	2.29	2.29	2.29	2.29	2.29	2.29	2.29	2.29	2.10
7500	2.04	2.12	2.12	2.12	1.25	2.12	2.12	2.12	2.10
9000	1.30	1.55	1.55	1.55	0.53	1.04	1.42	1.55	0.53
10500	0.90	1.06	1.06	1.06	0.27	0.55	0.87	1.02	0.24
<b>C/Z250-24</b>									
3000	5.44	5.44	5.44	5.44	5.44	5.44	5.44	5.44	1.78
4500	5.44	5.44	5.44	5.44	5.44	5.44	5.44	5.44	1.90
6000	4.49	5.44	5.44	5.44	5.19	5.44	5.44	5.44	3.56
7500	2.70	4.93	4.93	4.93	2.06	4.00	4.93	4.93	3.52
9000	1.72	2.98	3.06	3.06	0.89	1.79	2.74	3.06	0.89
10500	1.18	2.01	2.11	2.11	0.47	0.92	1.58	2.00	0.41
12000	0.87	1.45	1.55	1.55	0.27	0.53	0.91	1.33	0.24
<b>C/Z300-24</b>									
3000	7.37	7.37	7.37	7.37	7.37	7.37	7.37	7.37	3.14
4500	7.23	7.23	7.23	7.23	7.23	7.23	7.23	7.23	3.35
6000	6.36	6.89	6.89	6.89	6.89	6.89	6.89	6.89	6.29
7500	3.97	6.48	6.48	6.48	4.67	6.48	6.48	6.48	6.27
9000	2.42	4.15	4.15	4.15	2.01	3.61	4.15	4.15	1.57
10500	1.63	2.78	2.86	2.86	1.02	2.09	2.77	2.86	0.73
12000	1.17	1.98	2.10	2.10	0.59	1.22	1.83	2.10	0.42
<b>C/Z350-19</b>									
4500	4.46	4.46	4.46	4.46	4.46	4.46	4.46	4.46	4.18
6000	4.03	4.03	4.03	4.03	4.03	4.03	4.03	4.03	7.84
7500	3.61	3.61	3.61	3.61	3.61	3.61	3.61	3.61	7.82
9000	2.80	3.22	3.22	3.22	2.98	3.22	3.22	3.22	1.96
10500	1.87	2.61	2.63	2.63	1.66	2.43	2.63	2.63	0.91
12000	1.34	1.88	1.93	1.93	0.97	1.64	1.90	1.93	0.52
13500	1.00	1.42	1.49	1.49	0.61	1.13	1.40	1.49	0.34
<b>C/Z350-30</b>									
6000	11.67	12.07	12.07	12.07	12.07	12.07	12.07	12.07	13.17
7500	6.98	11.29	11.29	11.29	10.64	11.29	11.29	11.29	13.04
9000	3.99	7.50	7.50	7.50	5.32	7.50	7.50	7.50	3.29
10500	2.56	4.97	5.16	5.17	2.86	4.71	5.16	5.17	1.53
12000	1.77	3.48	3.79	3.79	1.63	3.06	3.79	3.79	0.88
13500	1.30	2.56	2.92	2.92	1.00	2.03	2.75	2.92	0.56
15000	0.99	1.95	2.28	2.32	0.66	1.38	2.01	2.32	0.39

**NOTE:** Bolting of section sizes from 100 to 250mm inclusive requires M12 grade 4.6 bolts. 300mm and 350mm sections require M16 grade 4.6 bolts. Shaded values require grade 8.8 bolts.





