

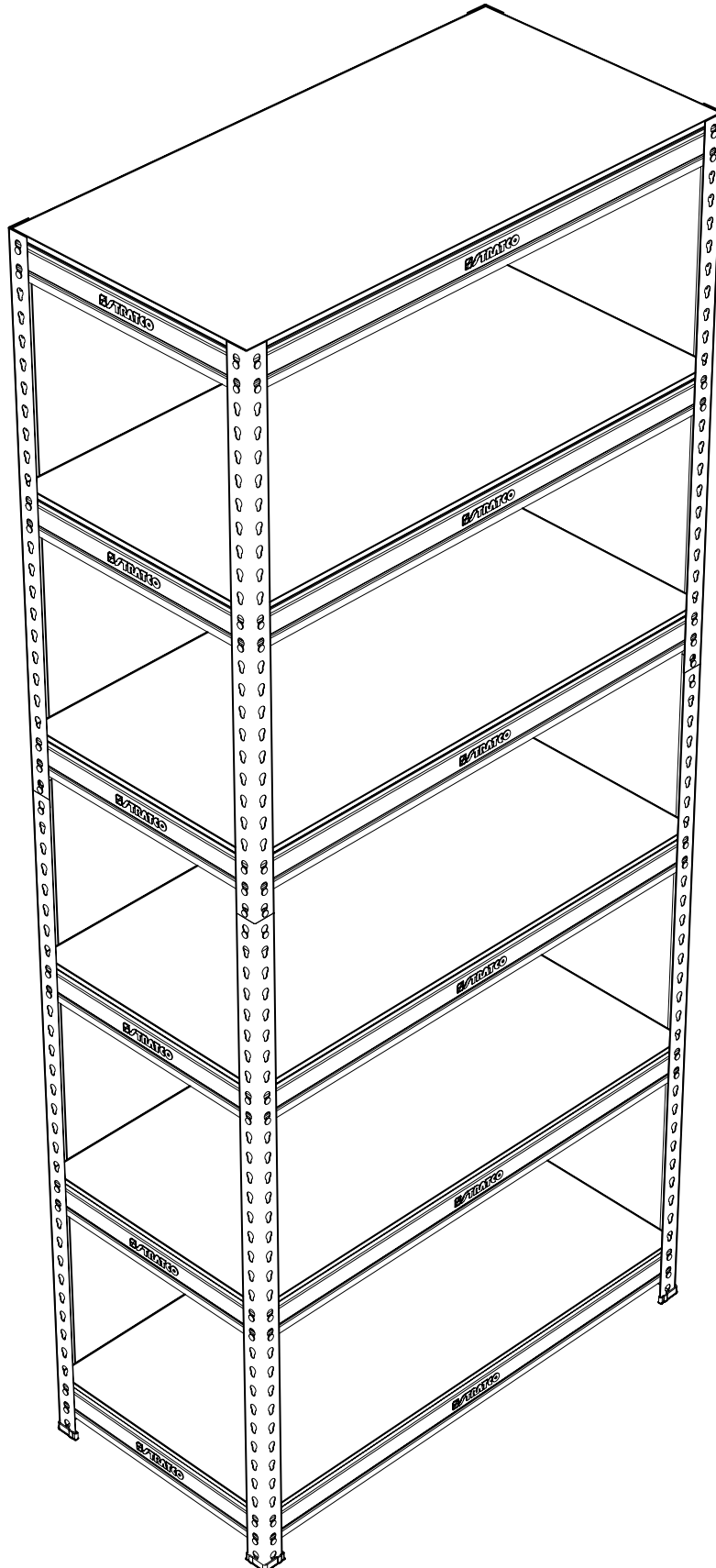

Rivet Lock Shelving Kit

6-SHELF ASSEMBLY



COMPONENTS

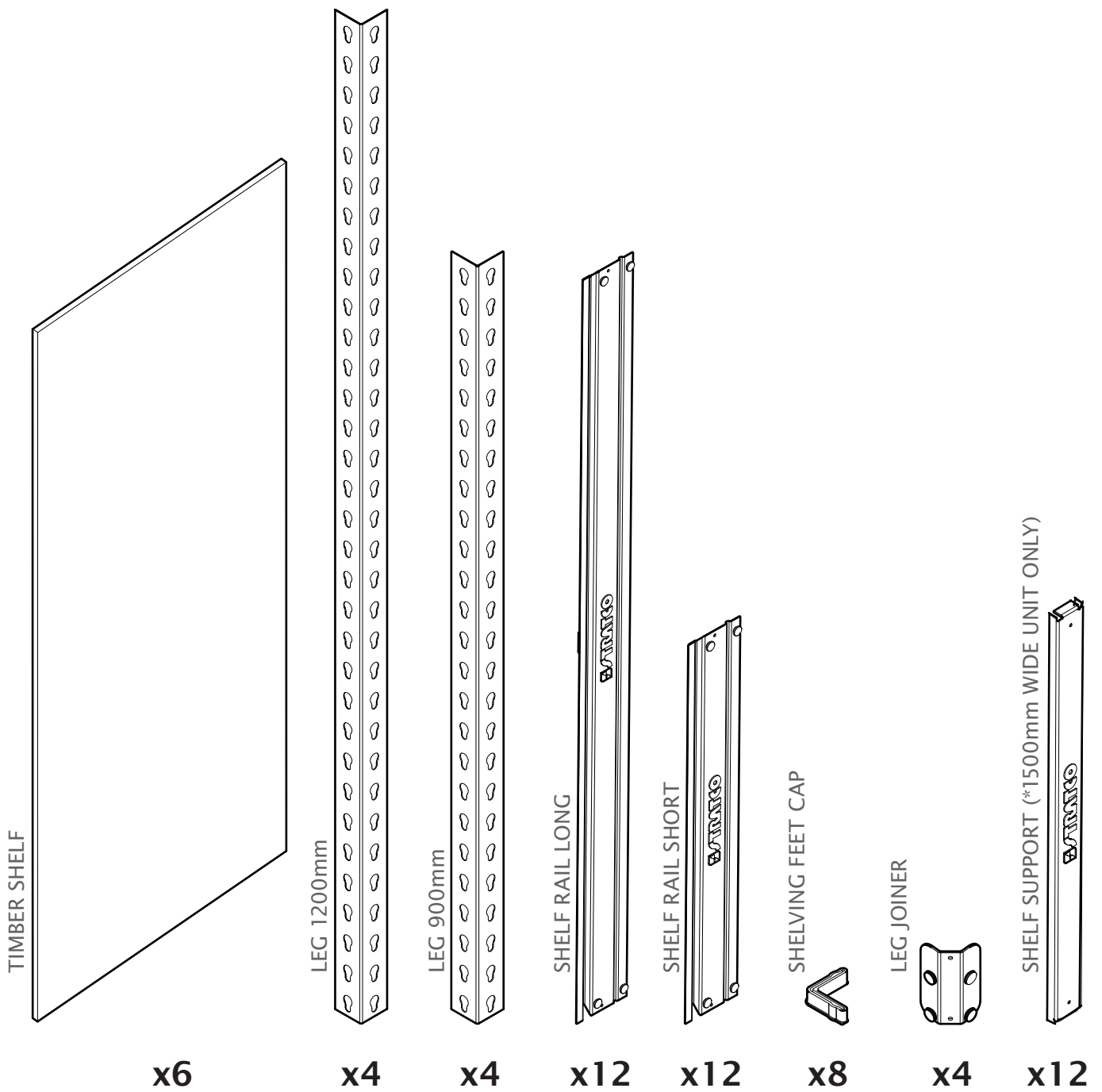

TOOL REQUIRED

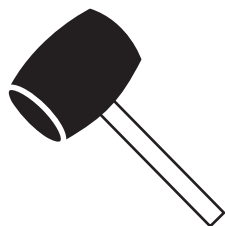

1x RUBBER Mallet

ASSEMBLY

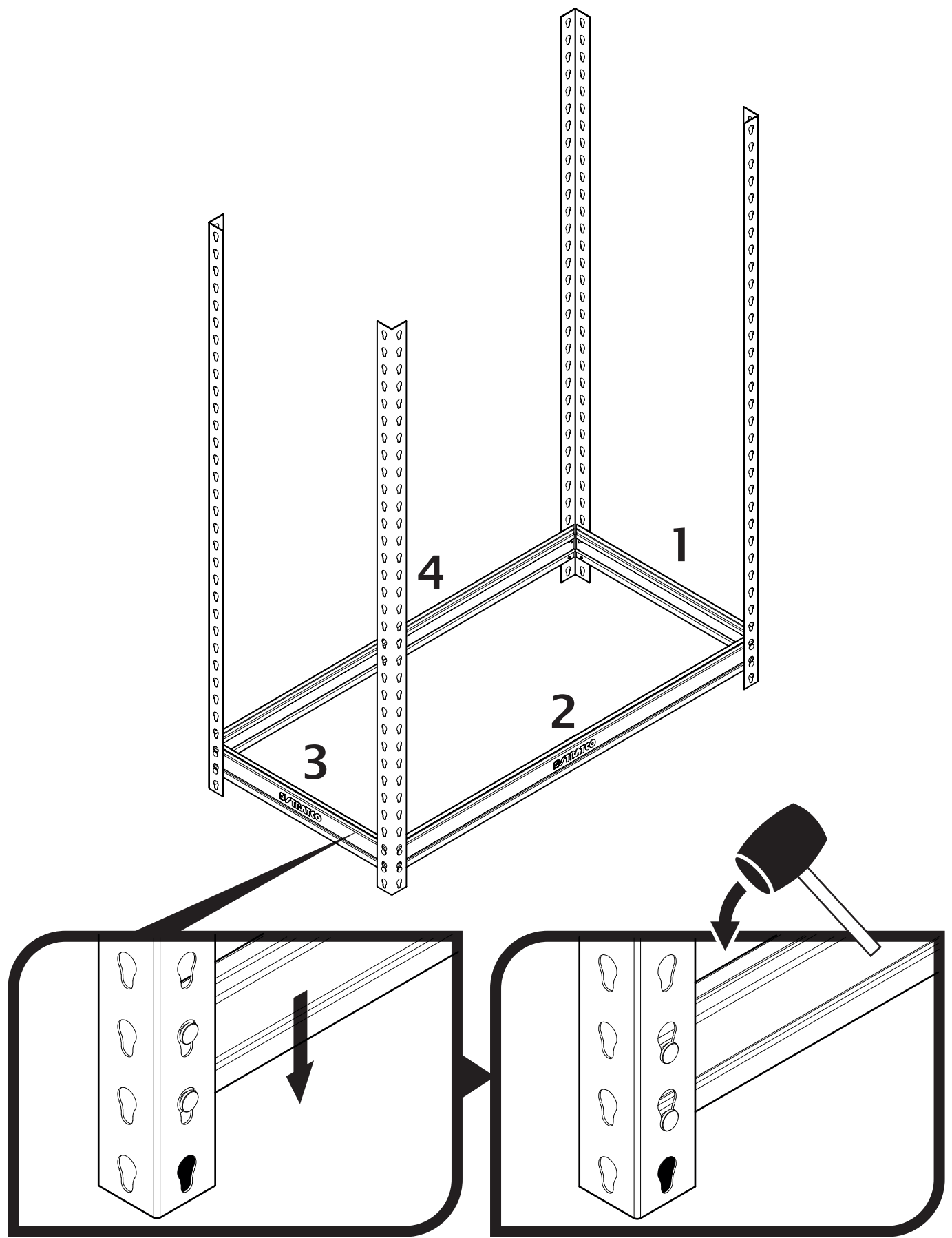

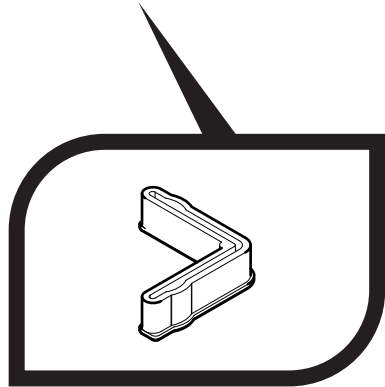
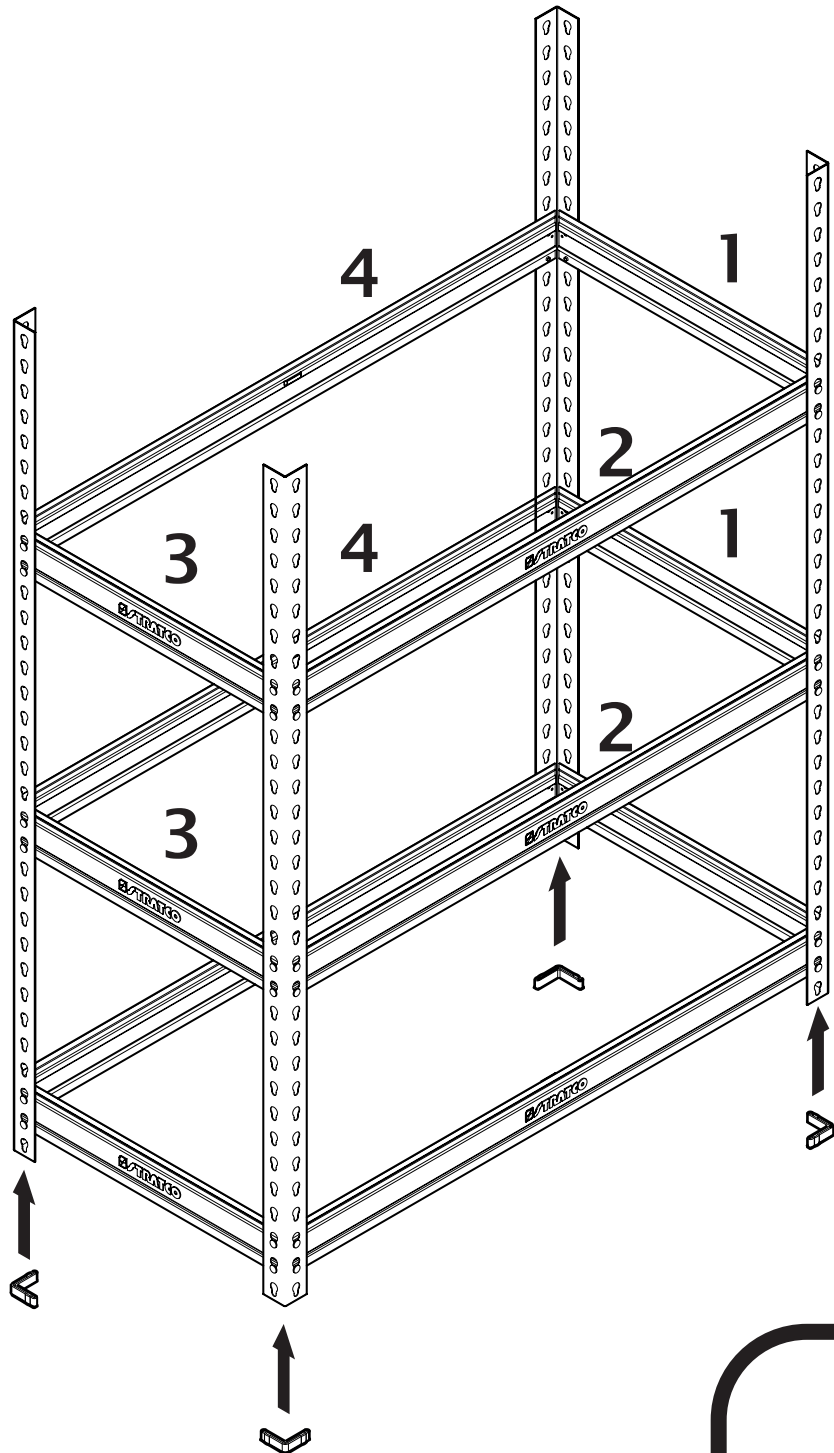

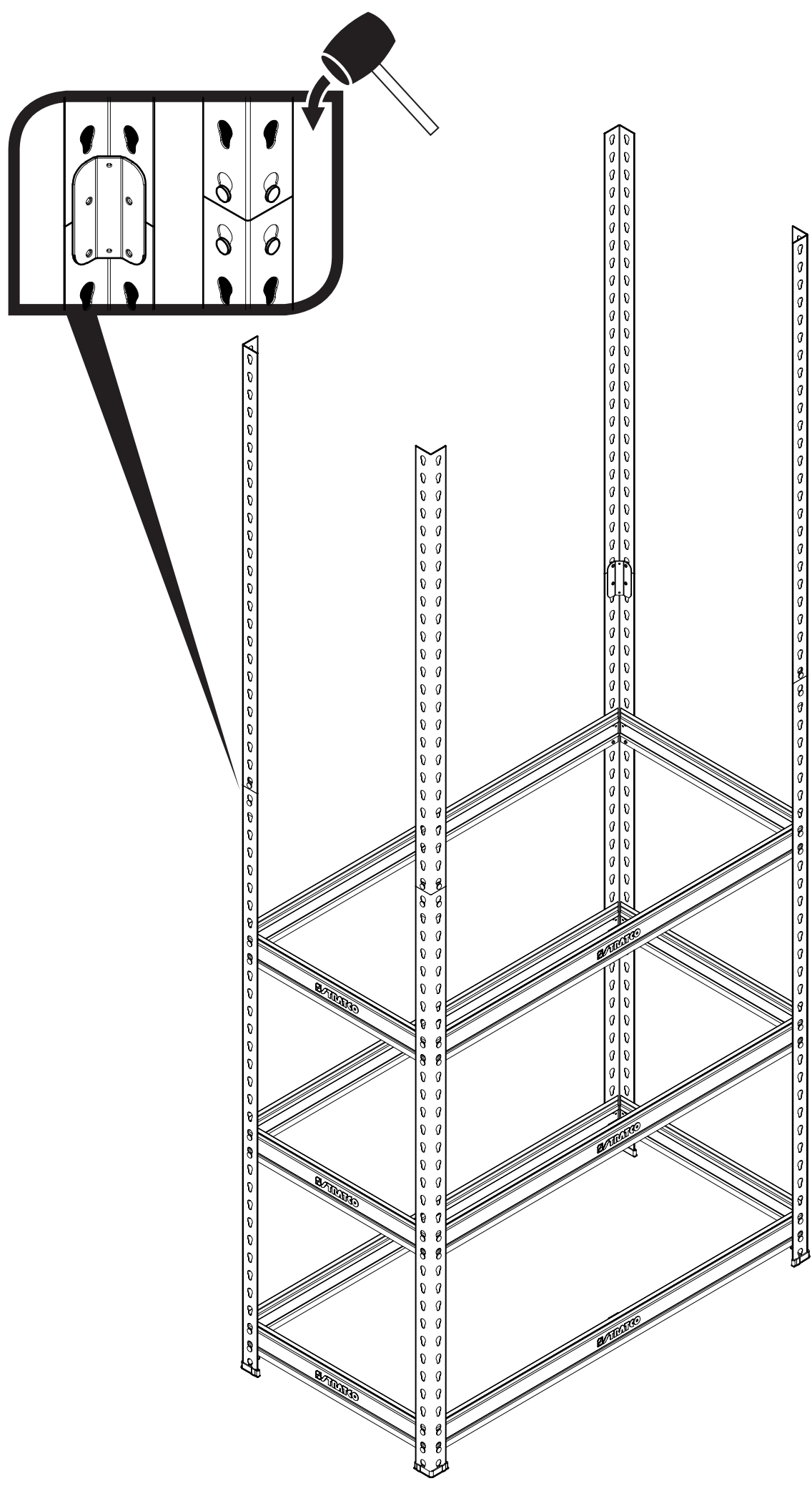

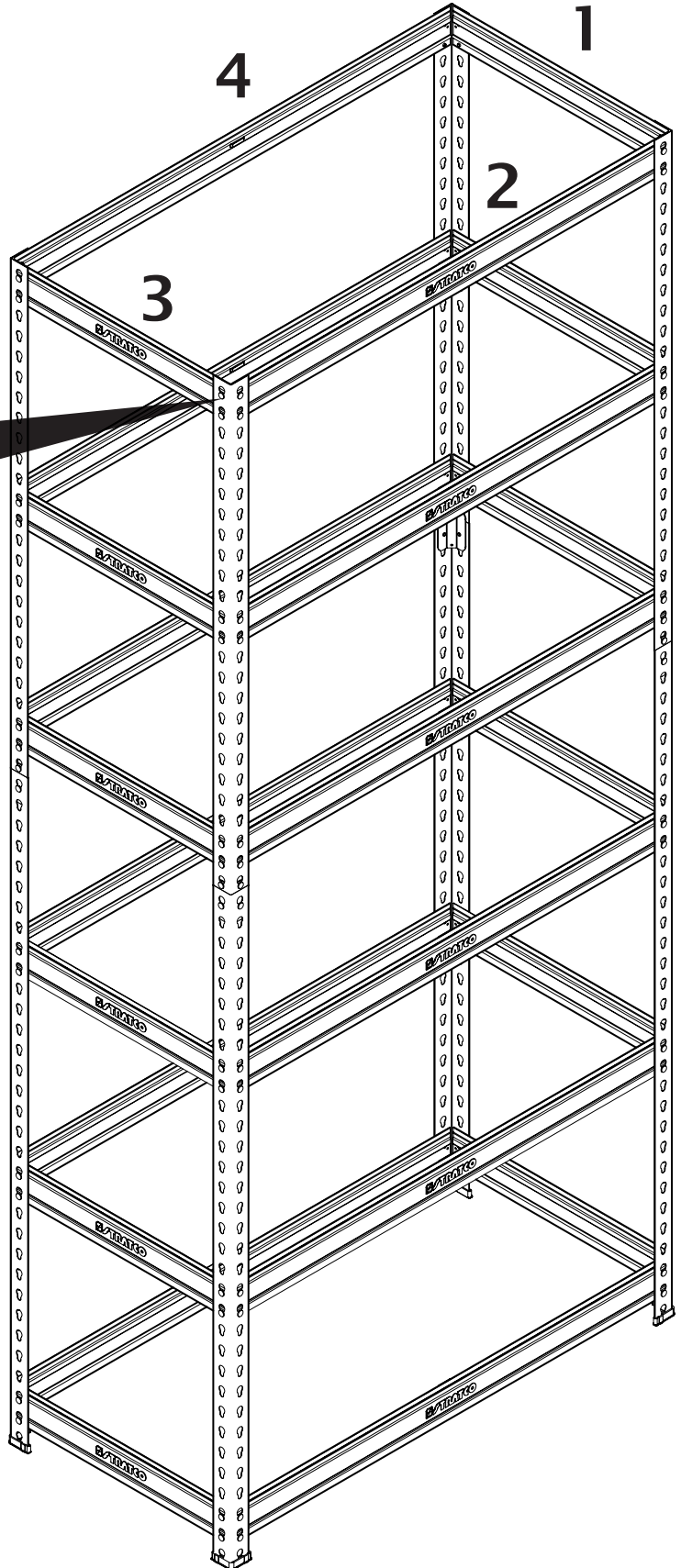
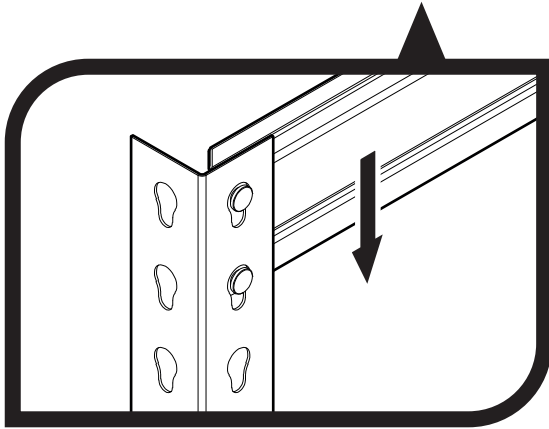
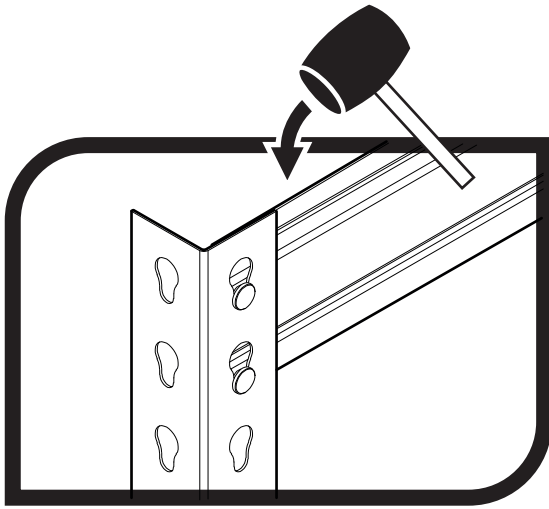

NOTE:
For the 1500mm wide unit you will need to install the two supplied shelf supports on the long rail for each shelf.

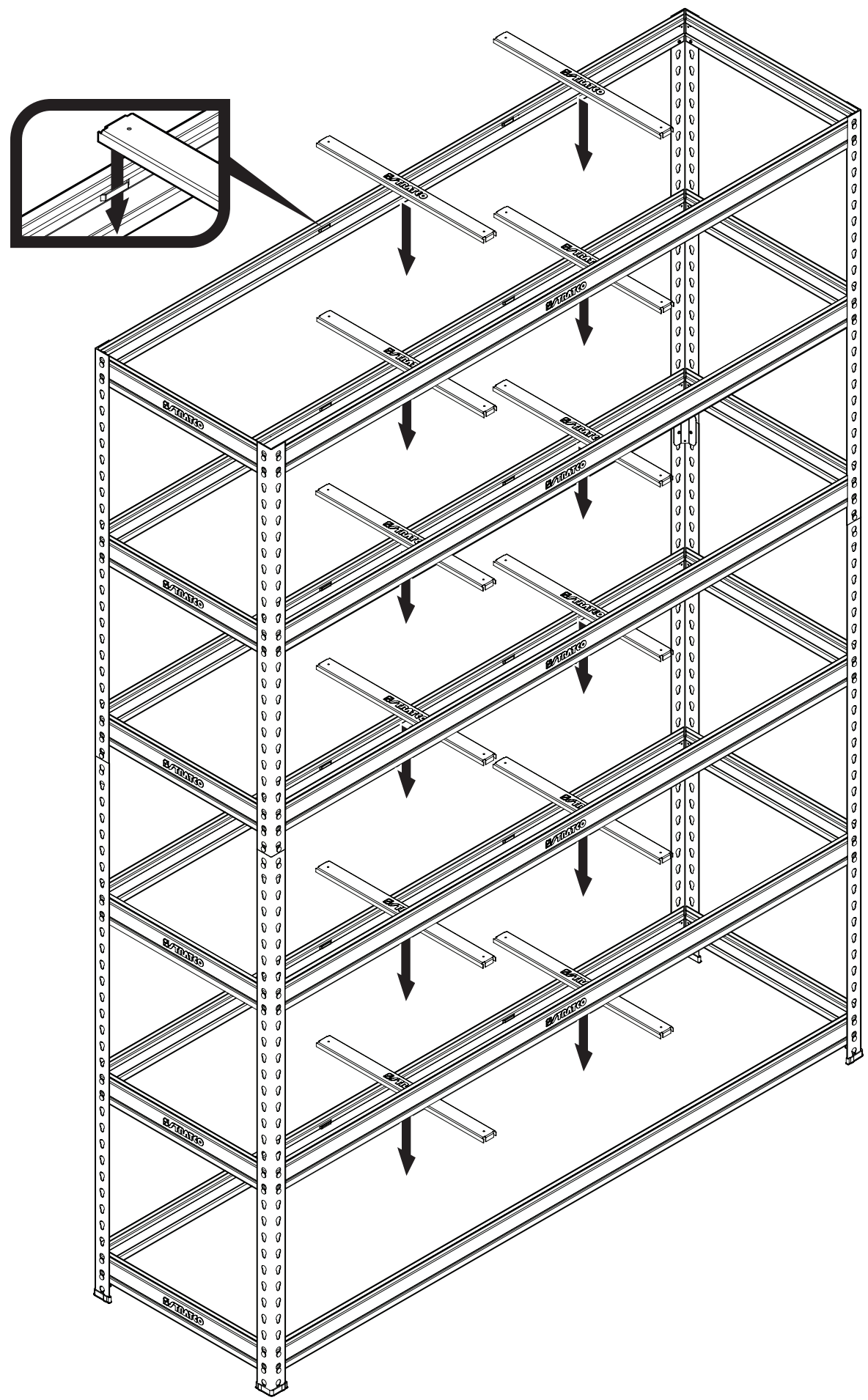

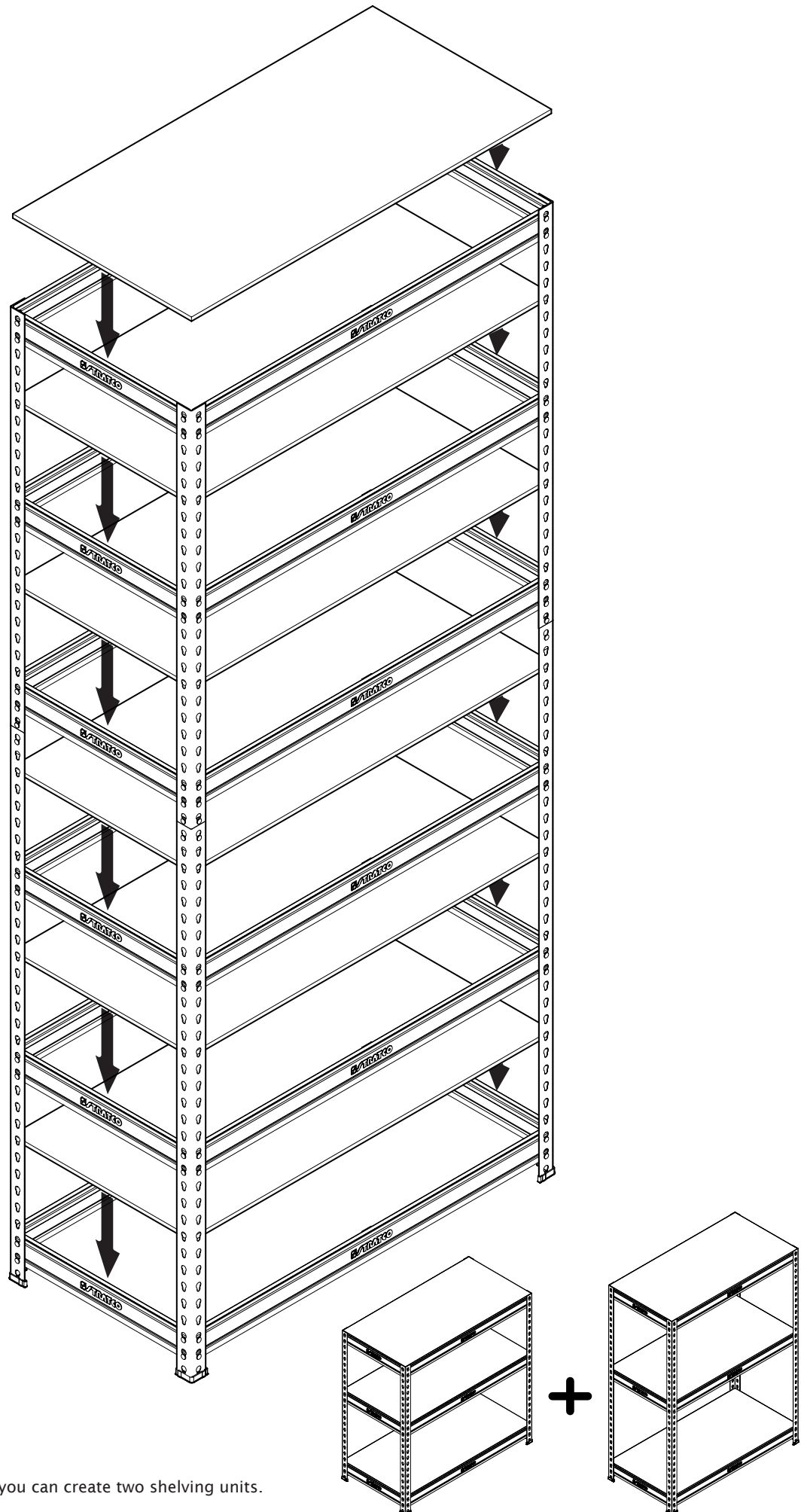

NOTE:
Using another four feet caps, you can create two shelving units.

